

Report on the Radio Testing
For
Raspberry Pi (Trading) Ltd
on
Raspberry Pi 3
Report no. TRA-029073-45-00B
18th February 2016

RF915 2.0

Report Number: TRA-029073-45-00B
Issue: B

REPORT ON THE RADIO TESTING OF A
Raspberry Pi (Trading) Ltd
Raspberry Pi 3
WITH RESPECT TO SPECIFICATION
FCC 47CFR 15.247 & IC RSS-247

TEST DATE: 2016-01-29

Written by: A Longley

A Longley
Radio Test Engineer

Approved by:

J Charters
Department Manager - Radio

Date: 18th February 2016

Disclaimers:

- [1] THIS DOCUMENT MAY BE REPRODUCED ONLY IN ITS ENTIRETY AND WITHOUT CHANGE
[2] THE RESULTS CONTAINED IN THIS DOCUMENT RELATE ONLY TO THE ITEM(S) TESTED

RF915 2.0

1 Revision Record

<i>Issue Number</i>	<i>Issue Date</i>	<i>Revision History</i>
B	18th February 2016	Update band edge plots
A	18th February 2016	Original

2 Summary

TEST REPORT NUMBER: TRA-029073-45-00B

WORKS ORDER NUMBER: TRA-029073-01

PURPOSE OF TEST: USA: Testing of radio frequency equipment per the relevant authorization procedure of chapter 47 of CFR (code of federal regulations) Part 2, subpart J.

Canada: Testing of radio apparatus for TAC (technical acceptance certificate) per subsections 4(2) of the Radiocommunication Act and 21(1) of the Radiocommunication Regulations.

TEST SPECIFICATION(S): 47CFR15.247 & RSS-247

EQUIPMENT UNDER TEST (EUT): Raspberry Pi 3

FCC IDENTIFIER: 2ABCB-RPI32

IC IDENTIFIER: 20953-RPI32

EUT SERIAL NUMBER: Prototype

MANUFACTURER/AGENT: Raspberry Pi (Trading) Ltd

ADDRESS: Mount Pleasant House
Mount Pleasant
Cambridge
CB3 0RN
United Kingdom

CLIENT CONTACT: Gordon Hollingworth
☎ 01223 322633
✉ gordon@raspberrypi.org

ORDER NUMBER: PO-0175

TEST DATE: 2016-01-29

TESTED BY: A Longley
Element

2.1 Test Summary

Test Method and Description		Requirement Clause		Applicable to this equipment	Result / Note
		RSS	47CFR15		
Radiated spurious emissions (restricted bands of operation and cabinet radiation)		Gen, 8.10	15.205	<input checked="" type="checkbox"/>	Pass
AC power line conducted emissions		Gen, 8.8	15.207	<input checked="" type="checkbox"/>	Pass
Occupied bandwidth		247, 5.2 (1)	15.247(a)(2)	<input checked="" type="checkbox"/>	Pass
Conducted carrier power	Peak	247, 5.4 (4)	15.247(b)(3)	<input checked="" type="checkbox"/>	Pass
	Max.			<input type="checkbox"/>	
Conducted / radiated RF power out-of-band		247, 5.5	15.247(d)	<input checked="" type="checkbox"/>	Pass
Power spectral density, conducted		247, 5.2 (2)	15.247(e)	<input checked="" type="checkbox"/>	Pass
Calculation of duty correction		-	15.35(c)	<input type="checkbox"/>	N/A
Radiated spurious emissions (receive mode)		-	15.109	<input checked="" type="checkbox"/>	Pass

Notes:

The results contained in this report relate only to the items tested, in the condition at time of test, and were obtained in the period between the date of initial receipt of samples and the date of issue of the report.

The apparatus was set up and exercised using the configurations, modes of operation and arrangements defined in this report only. Any modifications made are identified in Section 8 of this report.

Particular operating modes, apparatus monitoring methods and performance criteria required by the standards tested to have been performed except where identified in Section 5.2 of this test report (Deviations from Test Standards).

3 Contents

1	Revision Record.....	3
2	Summary.....	4
2.1	Test Summary.....	5
3	Contents.....	6
4	Introduction.....	8
5	Test Specifications.....	9
5.1	Normative References.....	9
5.2	Deviations from Test Standards.....	9
6	Glossary of Terms.....	10
7	Equipment Under Test.....	11
7.1	EUT Identification.....	11
7.2	System Equipment.....	11
7.3	EUT Mode of Operation.....	11
7.3.1	Transmission.....	11
7.3.2	Reception.....	11
7.4	EUT Radio Parameters.....	12
7.4.1	General.....	12
7.4.2	Antennas.....	12
7.4.3	Product specific declarations.....	13
7.5	EUT Description.....	13
8	Modifications.....	14
9	EUT Test Setup.....	15
9.1	Block Diagram.....	15
9.2	General Set-up Photograph.....	16
10	General Technical Parameters.....	17
10.1	Normal Conditions.....	17
10.2	Varying Test Conditions.....	17
11	Radiated emissions.....	18
11.1	Definitions.....	18
11.2	Test Parameters.....	18
11.3	Test Limit.....	18
11.4	Test Method.....	19
11.5	Test Set-up Photograph.....	20
11.6	Test Equipment.....	21
11.7	Test Results.....	22
12	AC power-line conducted emissions.....	87
12.1	Definition.....	87
12.2	Test Parameters.....	87
12.3	Test Limit.....	87
12.4	Test Method.....	88
12.5	Test Set-up Photograph.....	89
12.6	Test Equipment.....	89
12.7	Test Results.....	90
13	Occupied Bandwidth.....	91
13.1	Definition.....	91
13.2	Test Parameters.....	91
13.3	Test Limit.....	91
13.4	Test Method.....	92
13.5	Test Equipment.....	92
13.6	Test Results.....	93
14	Maximum peak conducted output power.....	117
14.1	Definition.....	117
14.2	Test Parameters.....	117
14.3	Test Limit.....	117
14.4	Test Method.....	118
14.5	Test Equipment.....	118
14.6	Test Results.....	118
15	Out-of-band and conducted spurious emissions.....	120
15.1	Definition.....	120
15.2	Test Parameters.....	120
15.3	Test Limit.....	120
15.4	Test Method.....	121
15.5	Test Equipment.....	121

15.6	Test Results	122
16	Power spectral density	218
16.1	Definition	218
16.2	Test Parameters.....	218
16.3	Test Limit	218
16.4	Test Method	219
16.5	Test Equipment.....	219
16.6	Test Results	219
17	Radiated emissions – unintentional radiation / receiver emissions	221
17.1	Definitions	221
17.2	Test Parameters.....	221
17.3	Test Limit	221
17.4	Test Method	222
17.5	Test Equipment.....	223
17.6	Test Results	224
18	Measurement Uncertainty	235
19	RF Exposure	236

4 Introduction

This report TRA-029073-45-00B presents the results of the Radio testing on a Raspberry Pi (Trading) Ltd, Raspberry Pi 3 to specification 47CFR15 Radio Frequency Devices and RSS-247 Digital Transmission Systems (DTSs), Frequency Hopping Systems (FHSs) and Licence-Exempt Local Area Network (LE_LAN) Devices.

The testing was carried out for Raspberry Pi (Trading) Ltd by Element, at the address(es) detailed below.

<input checked="" type="checkbox"/>	Element Hull Unit E South Orbital Trading Park Hedon Road Hull HU9 1NJ UK	<input type="checkbox"/>	Element North West Unit 1 Pendle Place Skemersdale West Lancashire WN8 9PN UK
-------------------------------------	---	--------------------------	---

This report details the configuration of the equipment, the test methods used and any relevant modifications where appropriate.

All test and measurement equipment under the control of the laboratory and requiring calibration is subject to an established programme and procedures to control and maintain measurement standards. The quality management system meets the principles of ISO 9001, and has quality control procedures for monitoring the validity of tests undertaken. Records and sufficient detail are retained to establish an audit trail of calibration records relating to its test results for a defined period. Under control of the established calibration programme, key quantities or values of the test & measurement instrumentation are within specification and comply with the relevant traceable internationally recognised and appropriate standard specifications, which are UKAS calibrated as such where these properties have a significant effect on results. Participation in inter-laboratory comparisons and proficiency testing ensures satisfactory correlation of results conform to Elements own procedures, as well as statistical techniques for analysis of test data providing the appropriate confidence in measurements.

Throughout this report EUT denotes equipment under test.

FCC Site Listing:

Element is accredited for the above sites under the US-EU MRA, Designation number UK0009.

IC Registration Number(s):

Element North West	3930B
Element Hull	3483A-1

The test site requirements of ANSI C63.4-2014 are met up to 1GHz.

The test site SVSWR requirements of CISPR 16-1-4:2010 are met over the frequency range 1 GHz to 18 GHz.

5 Test Specifications

5.1 Normative References

- FCC 47 CFR Ch. I – Part 15 – Radio Frequency Devices.
- ANSI C63.10-2013 – American National Standard of Procedures for Compliance Testing of Unlicensed Wireless Devices.
- ANSI C63.4-2014 – American National Standard for Methods of Measurement of Radio-Noise Emissions from Low-Voltage Electrical and Electronic Equipment in the Range of 9 kHz to 40 GHz.
- Industry Canada RSS-210, Issue 8, December 2010 – Licence-exempt Radio Apparatus (All Frequency Bands): Category I Equipment.
- Industry Canada RSS-247, Issue 1, May 2015 – Digital Transmission Systems (DTSs), Frequency Hopping Systems (FHSs) and Licence-Exempt Local Area Network (LE-LAN) Devices
- Industry Canada RSS-Gen, Issue 4, November 2014 – General Requirements for Compliance of Radio Apparatus

5.2 Deviations from Test Standards

There were no deviations from the test standard.

6 Glossary of Terms

§	denotes a section reference from the standard, not this document
AC	Alternating Current
ANSI	American National Standards Institute
BW	bandwidth
C	Celsius
CFR	Code of Federal Regulations
CW	Continuous Wave
dB	decibel
dBm	dB relative to 1 milliwatt
DC	Direct Current
DSSS	Direct Sequence Spread Spectrum
EIRP	Equivalent Isotropically Radiated Power
ERP	Effective Radiated Power
EUT	Equipment Under Test
FCC	Federal Communications Commission
FHSS	Frequency Hopping Spread Spectrum
Hz	hertz
IC	Industry Canada
ITU	International Telecommunication Union
LBT	Listen Before Talk
m	metre
max	maximum
MIMO	Multiple Input and Multiple Output
min	minimum
MRA	Mutual Recognition Agreement
N/A	Not Applicable
PCB	Printed Circuit Board
PDF	Portable Document Format
Pt-mpt	Point-to-multipoint
Pt-pt	Point-to-point
RF	Radio Frequency
RH	Relative Humidity
RMS	Root Mean Square
Rx	receiver
s	second
SVSWR	Site Voltage Standing Wave Ratio
Tx	transmitter
UKAS	United Kingdom Accreditation Service
V	volt
W	watt
Ω	ohm

7 Equipment Under Test

7.1 EUT Identification

- Name: Raspberry Pi 3
- Serial Number: Prototype
- Model Number: Model B
- Software Revision: V4.1
- Build Level / Revision Number: V1.2

7.2 System Equipment

Equipment listed below forms part of the overall test setup and is required for equipment functionality and/or monitoring during testing. The compliance levels achieved in this report relate only to the EUT and not items given in the following list.

Not Applicable – No support/monitoring equipment required.

7.3 EUT Mode of Operation

7.3.1 Transmission

The mode of operation for Tx tests was as follows:

Testing was performed with the EUT continuously transmitting in 802.11b, 802.11g and 802.11n modes, at both the fastest and slowest data rates supported by the device. Test levels were set using the “compliance_app.sh” script, the test scripts used during the assessment are on file at Element.

7.3.2 Reception

The mode of operation for Rx tests was as follows:

Testing was performed with the EUT in receive mode according to the “compliance_app.sh” script.

7.4 EUT Radio Parameters

7.4.1 General

Frequency of operation:	2400 to 2483.5 MHz (channelized)
Modulation type(s):	802.11b, 802.11g and 802.11n(HT20)
Occupied channel bandwidth(s):	22 MHz
Channel spacing:	5 MHz
ITU emission designator(s):	20MF7D
Declared output power(s):	19 dBm
Warning against use of alternative antennas in user manual (yes/no):	N/A (PCB mounted chip antenna)
Nominal Supply Voltage:	5Vdc (via USB power supply)
Location of notice for license exempt use:	Label / user manual / both.
Method of prevention of use on non-US / non-Canadian frequencies:	N/A (2.4 GHz operation only)

7.4.2 Antennas

Type:	AEL - A2450M000000S007
Frequency range:	2400 to 2500 MHz
Impedance:	50 Ω
SWR:	2.0 max.
Gain:	1.5 dBi max.
Polarisation:	Linear
Beam width:	Omni-directional
Connector type:	None
Length:	5.2 \pm 0.2 mm
Weight:	N/A
Environmental limits:	-40 to +85 °C / 55-75% RH
Mounting:	PCB mounted chip ceramic

7.4.3 Product specific declarations

Multiple antenna configuration(s), e.g. MIMO:	Single Antenna
Fixed pt-pt operations (yes/no):	No
Installation manual advice on pt-pt operational restrictions (yes/no):	N/A
Fixed pt-mpt operations (yes/no):	No

7.5 EUT Description

The EUT is small, single board, computer with WiFi, Bluetooth and Bluetooth LE connectivity.

8 Modifications

No modifications were performed during this assessment.

9 EUT Test Setup

9.1 Block Diagram

The following diagram shows basic EUT interconnections with cable type and cable lengths identified:

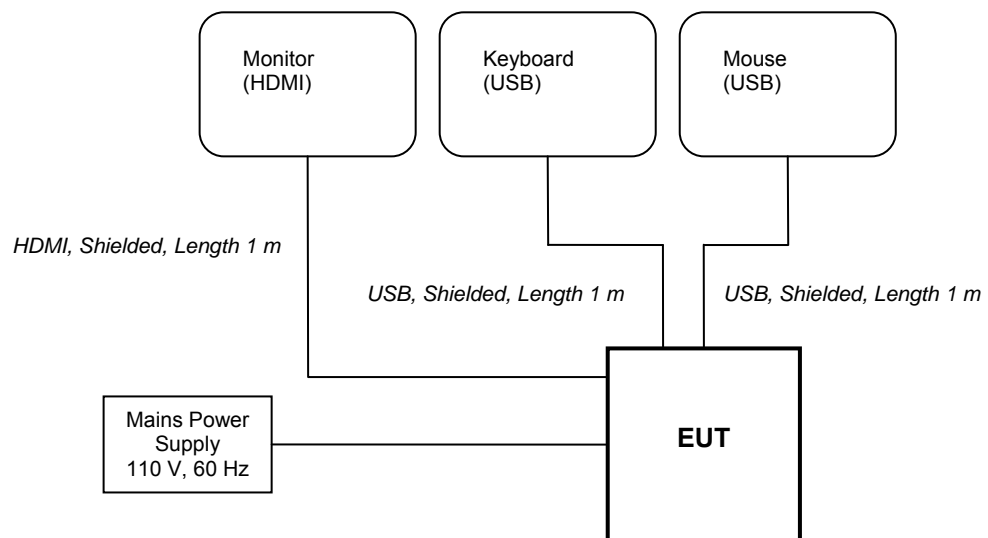

9.2 General Set-up Photograph

The following photograph shows basic EUT set-up:



10 General Technical Parameters

10.1 Normal Conditions

The E U T was tested under the normal environmental conditions of the test laboratory, except where otherwise stated. The normal power source applied was approx. 5 V dc from the adaptor / 110 V ac, 60 Hz, from the mains.

10.2 Varying Test Conditions

There are no specific frequency stability requirements for the type of device. The results contained in this report demonstrate that the occupied bandwidth is contained within the authorised band and the manufacturer has declared sufficient frequency stability (refer to section 7.4).

Variation of supply voltage is required to ensure stability of the declared output power. During carrier power testing the following variations were made:

	Category	Nominal	Variation
<input type="checkbox"/>	Mains	110 V ac +/-2 %	85 % and 115 %
<input type="checkbox"/>	Battery	New battery	N/A

11 Radiated emissions

11.1 Definitions

Spurious emissions

Emissions on a frequency or frequencies, which are outside the necessary bandwidth and the level of which may be reduced without affecting the corresponding transmission of information. Spurious emissions include harmonic emissions, parasitic emissions, intermodulation products and frequency conversion products, but exclude out-of-band emissions.

Restricted bands

A frequency band in which intentional radiators are permitted to radiate only spurious emissions but not fundamental signals.

11.2 Test Parameters

Test Location:	Element Hull
Test Chamber:	Lab 16 / Lab 10
Test Standard and Clause:	ANSI C63.10-2013, Clause 6.5 and 6.6
EUT Channels / Frequencies Measured:	Low / Mid / High
EUT Channel Bandwidths:	20 MHz
Deviations From Standard:	None
Measurement BW:	30 MHz to 1 GHz: 120 kHz Above 1 GHz: 1 MHz
Measurement Detector:	Up to 1 GHz: quasi-peak Above 1 GHz: RMS average and Peak

Environmental Conditions (Normal Environment)

Temperature: 22 °C	+15 °C to +35 °C (as declared)
Humidity: 32 % RH	20 % RH to 75 % RH (as declared)
Supply: 110 V ac	110 V ac ±10 % (as declared)

11.3 Test Limit

Unwanted emissions that fall within the restricted frequency bands shall comply with the limits specified:

General Field Strength Limits for License-Exempt Transmitters at Frequencies above 30 MHz

<i>Frequency (MHz)</i>	<i>Field Strength ($\mu\text{V/m}$ at 3 m)</i>
30 to 88	100
88 to 216	150
216 to 960	200
Above 960	500

11.4 Test Method

With the EUT setup as per section 9 of this report and connected as per Figure i, the emissions from the EUT were measured on a spectrum analyzer / EMI receiver.

Radiated electromagnetic emissions from the EUT are checked first by preview scans. Preview scans for all spectrum and modulation characteristics are checked, using a peak detector and where applicable worst-case determined for function, operation, orientation, etc. for both vertical and horizontal polarisations. Pre-scan plots are shown with a peak detector and 100 kHz RBW.

If the EUT connects to auxiliary equipment and is table or floor standing, the configurations prescribed in ANSI C63.10 are followed. Alternatively, a layout closest to normal use (as declared by the provider) is employed, (see EUT setup photographs for more detail).

Emissions between 30 MHz and 1 GHz are measured using calibrated broadband antennas. Emissions above 1 GHz are characterized using standard gain horn antennas. Pre-amplifiers and filters are used where required. Care is taken to ensure that test receiver resolution bandwidth, video bandwidth and detector type(s) meet the regulatory requirements.

For both horizontal and vertical polarizations, the EUT is then rotated through 360 degrees in azimuth until the highest emission is detected. At the previously determined azimuth the test antenna is raised and lowered from 1 to 4 m in height until a maximum emission level is detected, this maximum value is recorded.

Power values measured on the test receiver / analyzer are converted to field strength, FS, in dB μ V/m at the regulatory distance, using:

$$FS = PR + CL + AF - PA + DC - CF$$

Where,

PR is the power recorded on the receiver / spectrum analyzer in dB μ V;

CL is the cable loss in dB;

AF is the test antenna factor in dB/m;

PA is the pre-amplifier gain in dB (where used);

DC is the duty correction factor in dB (where used, e.g. harmonics of pulsed fundamental);

CF is the distance factor in dB (where measurement distance different to limit distance);

This field strength value is then compared with the regulatory limit.

Figure i Test Setup

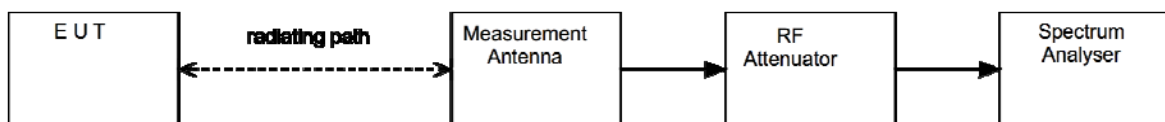

11.5 Test Set-up Photograph

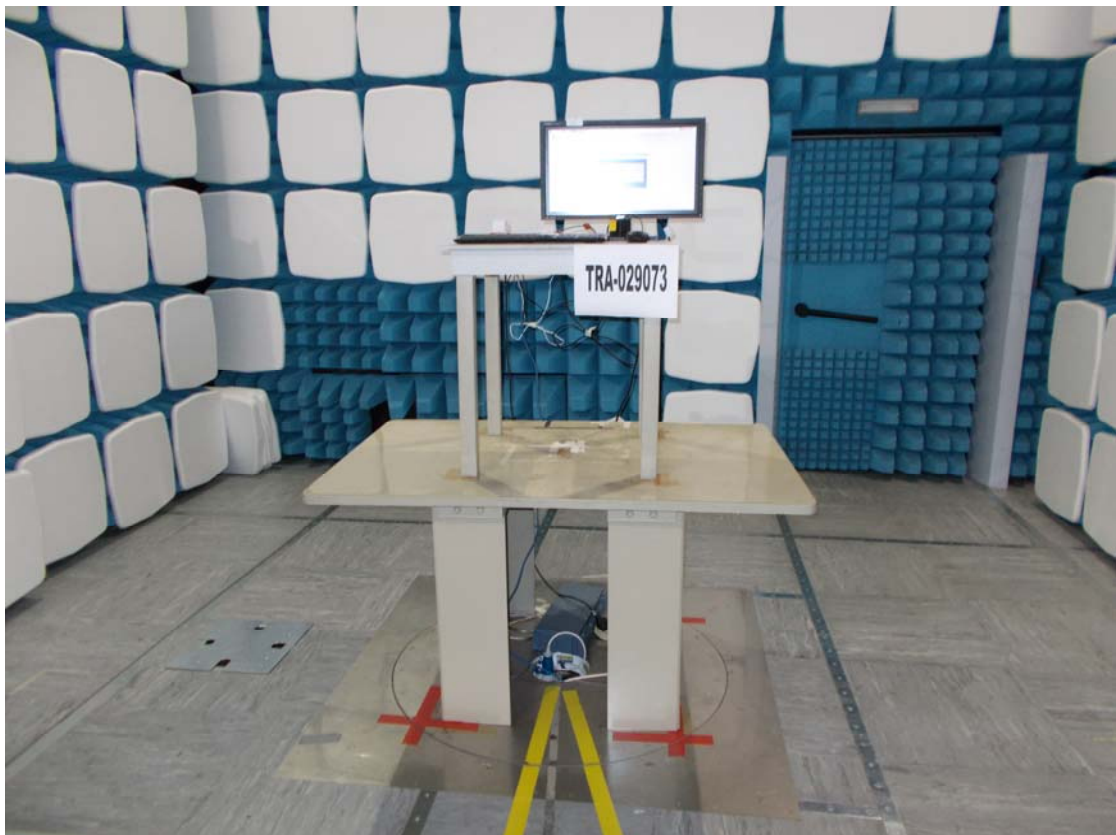



11.6 Test Equipment

Equipment Type	Manufacturer	Equipment Description	Element No	Due For Calibration	Calibration Interval (m)
ATS	Rainford	Ferrite Lined Chamber	REF886	21/07/2016	12
FSU46	R&S	Spectrum Analyser	REF910	28/05/2016	12
310	Sonoma	Pre-Amp (9kHz – 1GHz)	REF927	01/07/2016	12
8449B	Agilent	Pre-Amp (1 – 26.5GHz)	REF913	05/02/2016	12
3109	EMCO	Biconical Antenna	RFG095	09/05/2016	24
3146	EMCO	Log Periodic Antenna	RFG191	09/05/2016	24
3115	EMCO	Horn Antenna	RFG129	05/02/2016	24
	Q-Par	Horn Antenna	RFG629	30/09/2017	24
SN 4478	BSC	2.4 GHz Bandstop Filter	REF2158	Cal before use	N/A

11.7 Test Results

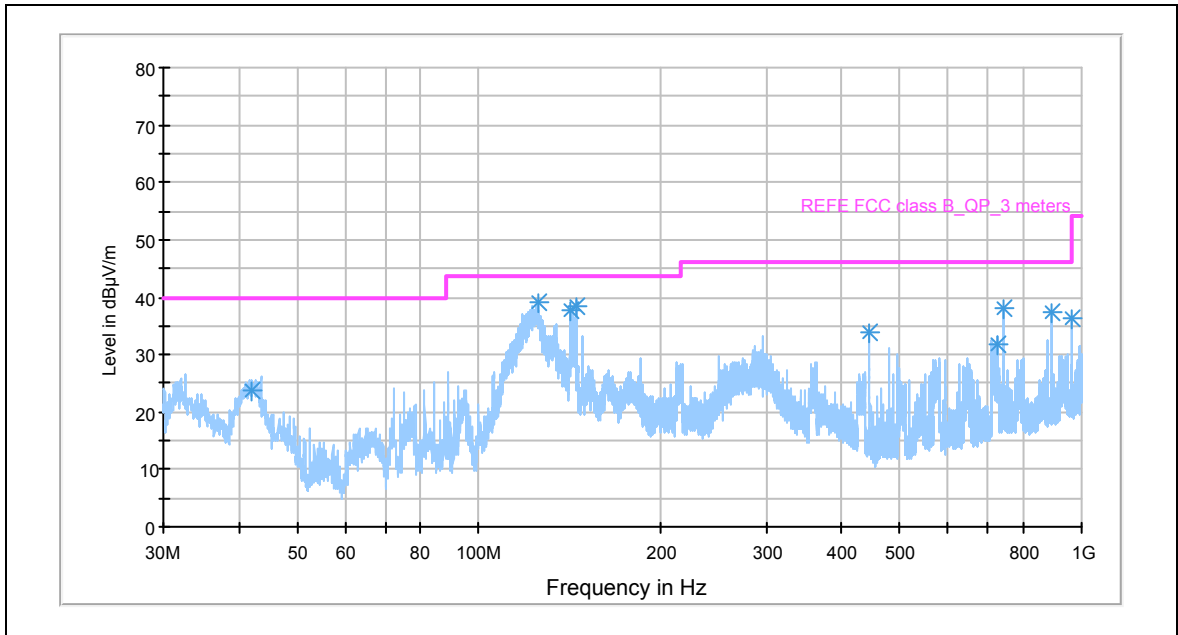

802.11b 1 Mbps Channel 1 : 30 MHz to 1 GHz

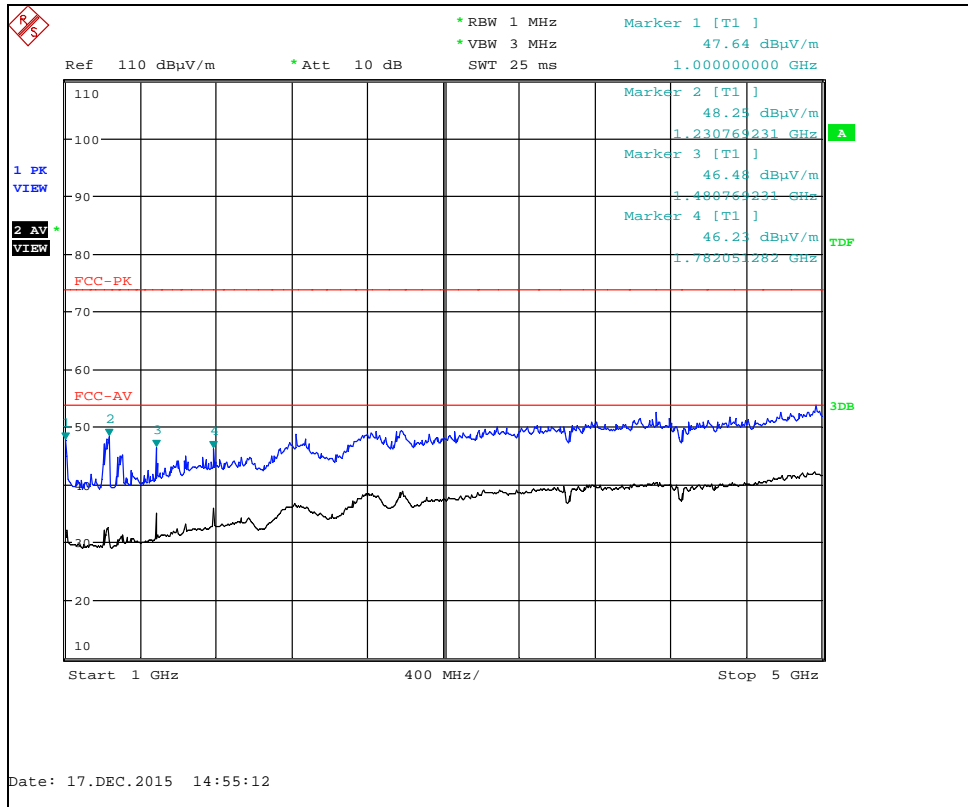

802.11b 1 Mbps Channel 1 : 1 GHz to 5 GHz

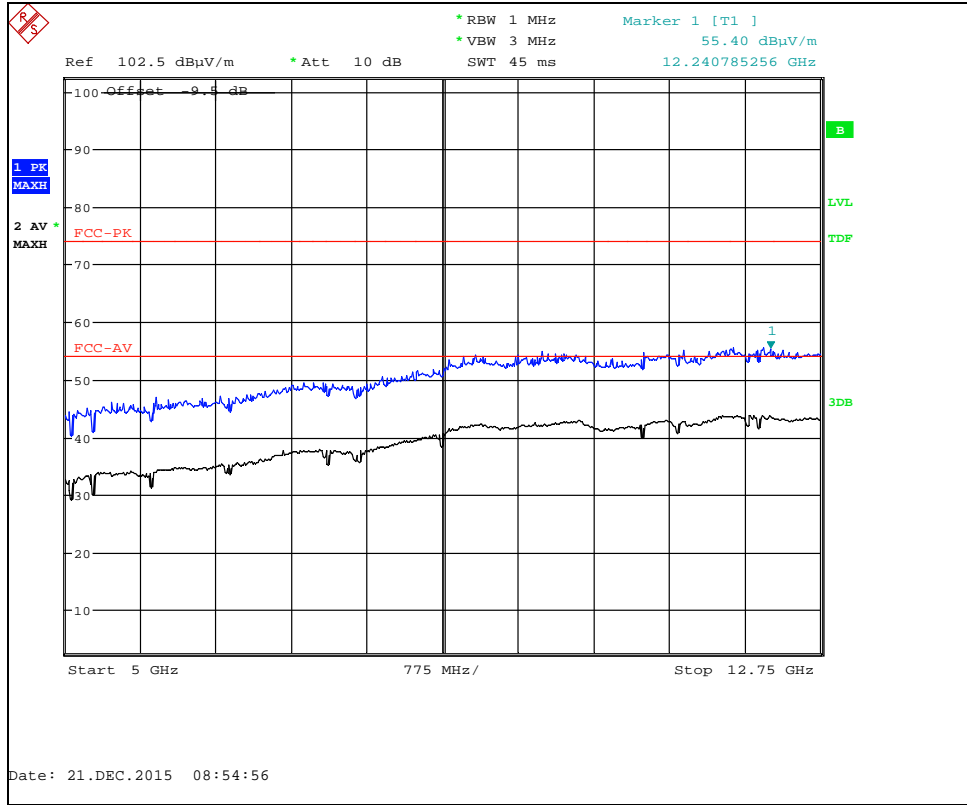

802.11b 1 Mbps Channel 1 : 5 GHz to 12.75 GHz

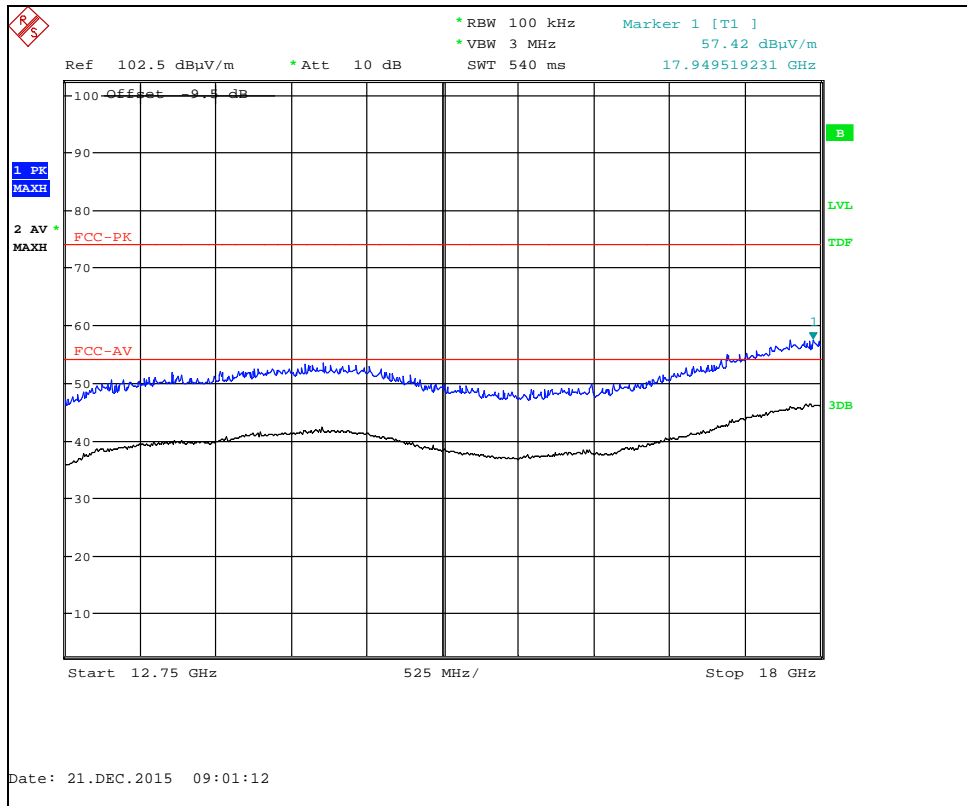

802.11b 1 Mbps Channel 1 : 12.75 GHz to 18 GHz

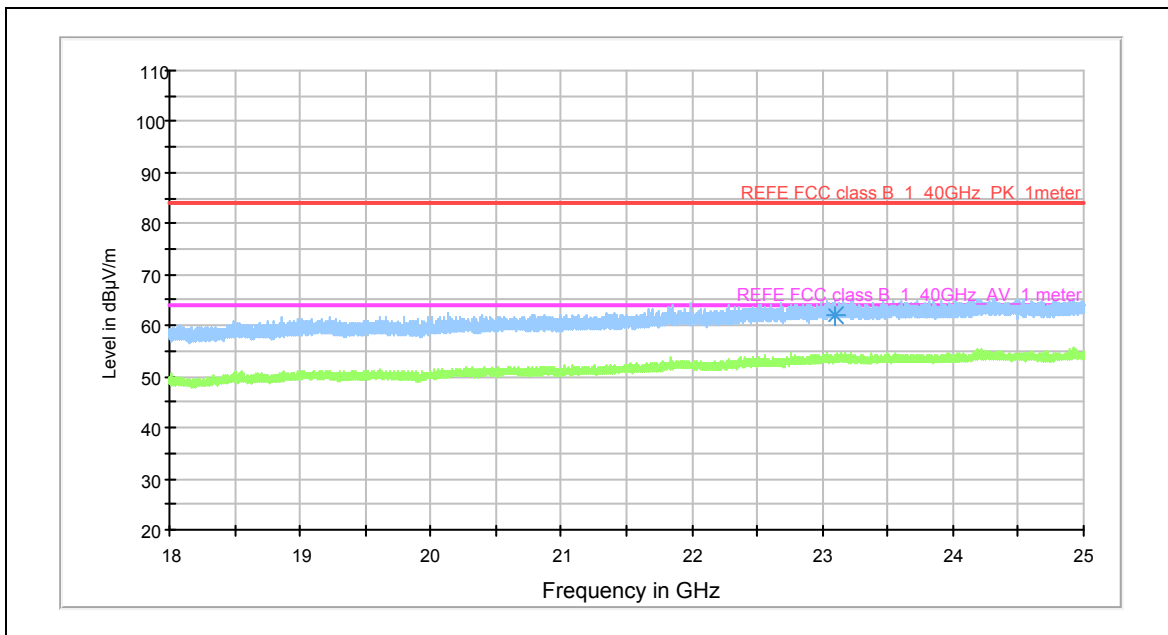

802.11b 1 Mbps Channel 1 : 18 GHz to 25 GHz

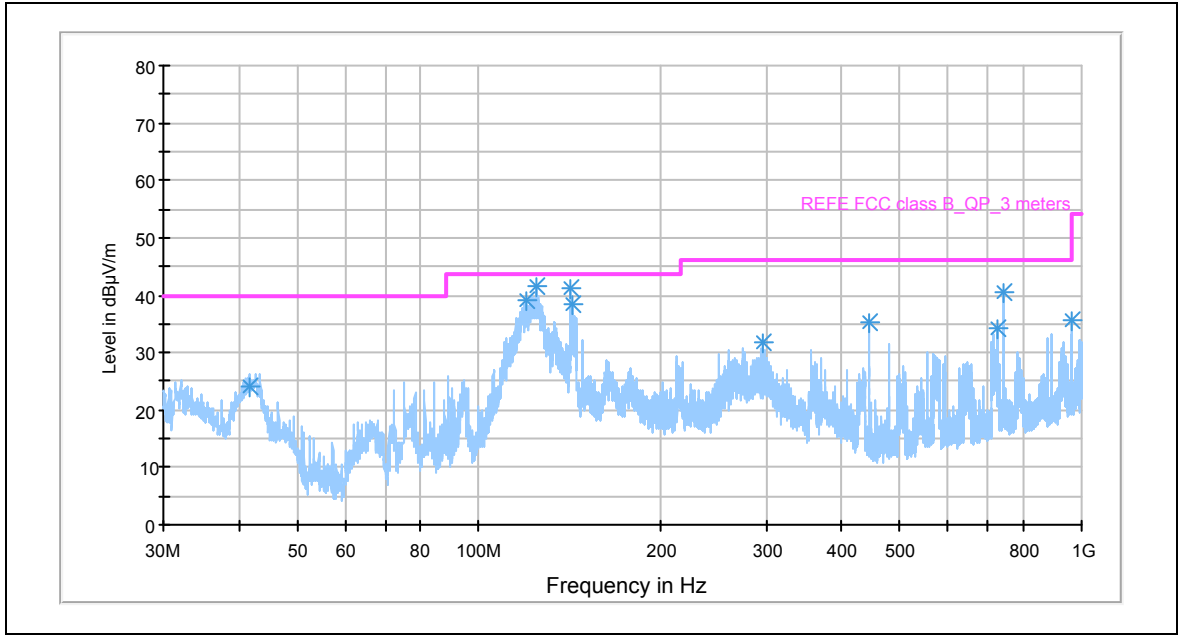

802.11b 1 Mbps Channel 6 : 30 MHz to 1 GHz

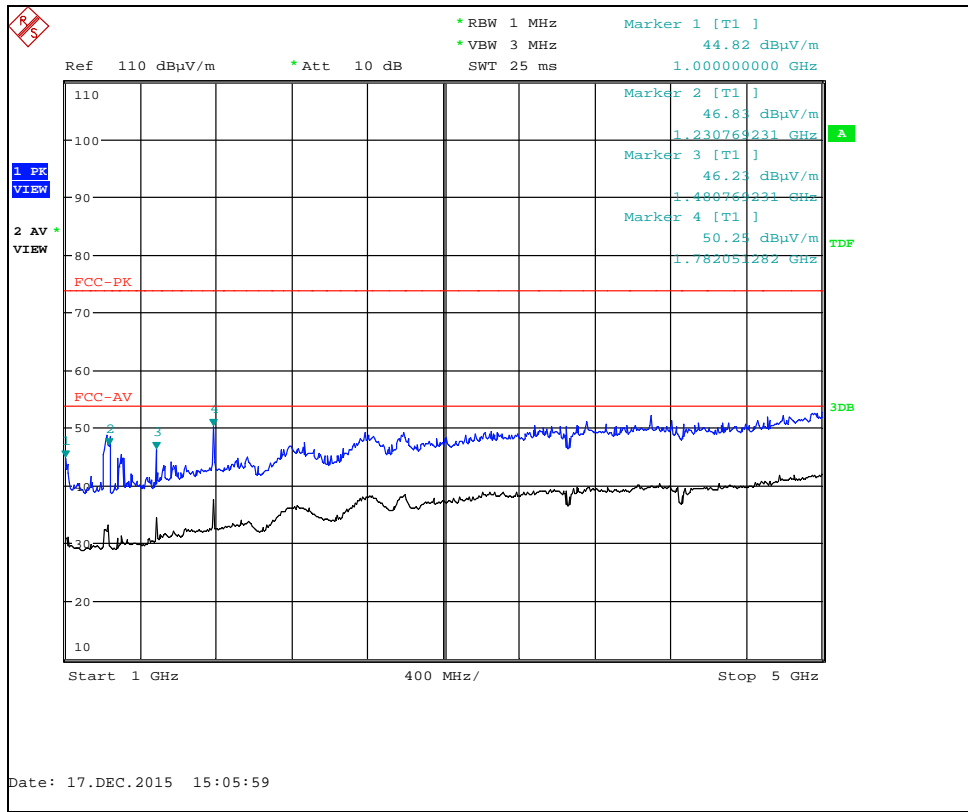

802.11b 1 Mbps Channel 6 : 1 GHz to 5 GHz

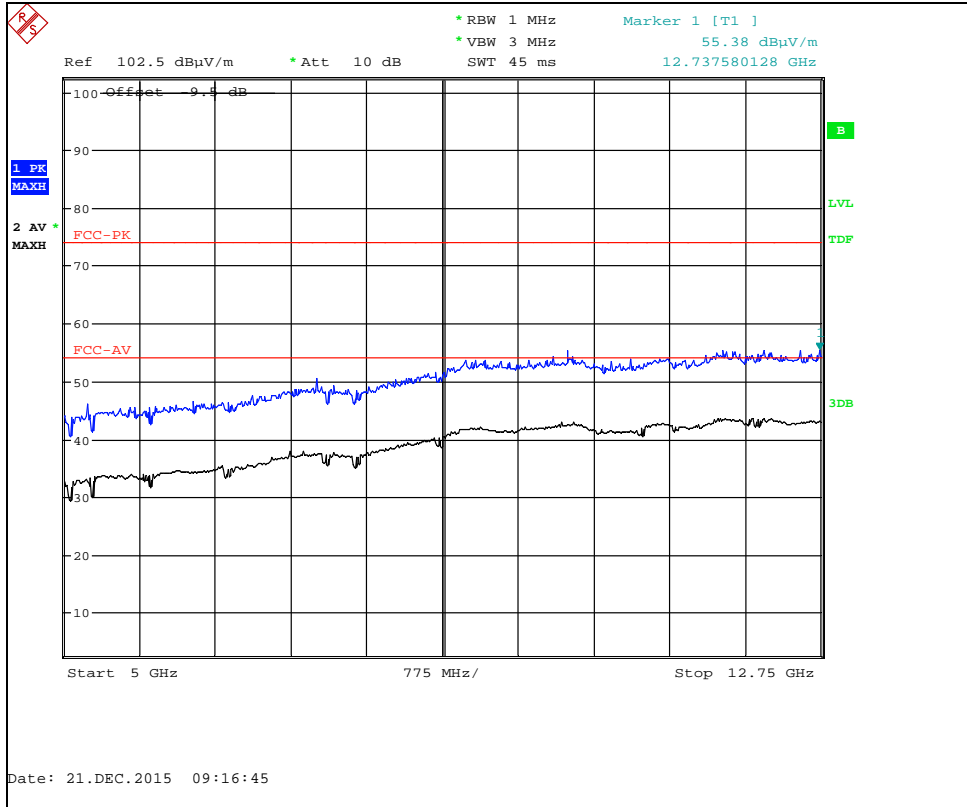

802.11b 1 Mbps Channel 6 : 5 GHz to 12.75 GHz

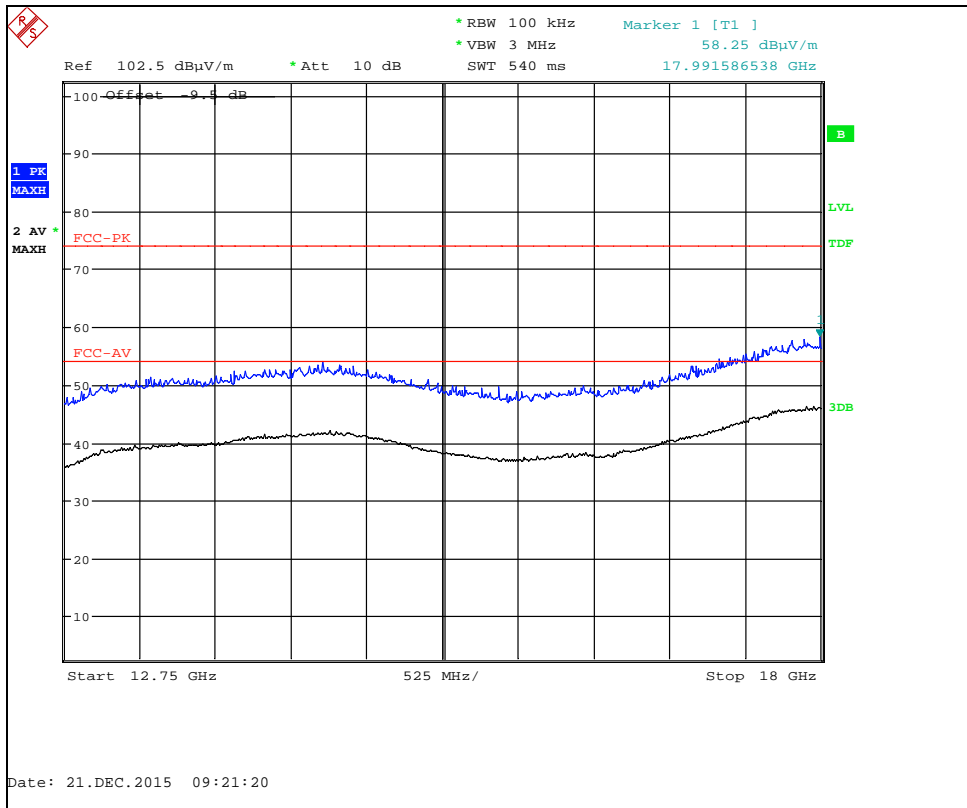

802.11b 1 Mbps Channel 6 : 12.75 GHz to 18 GHz

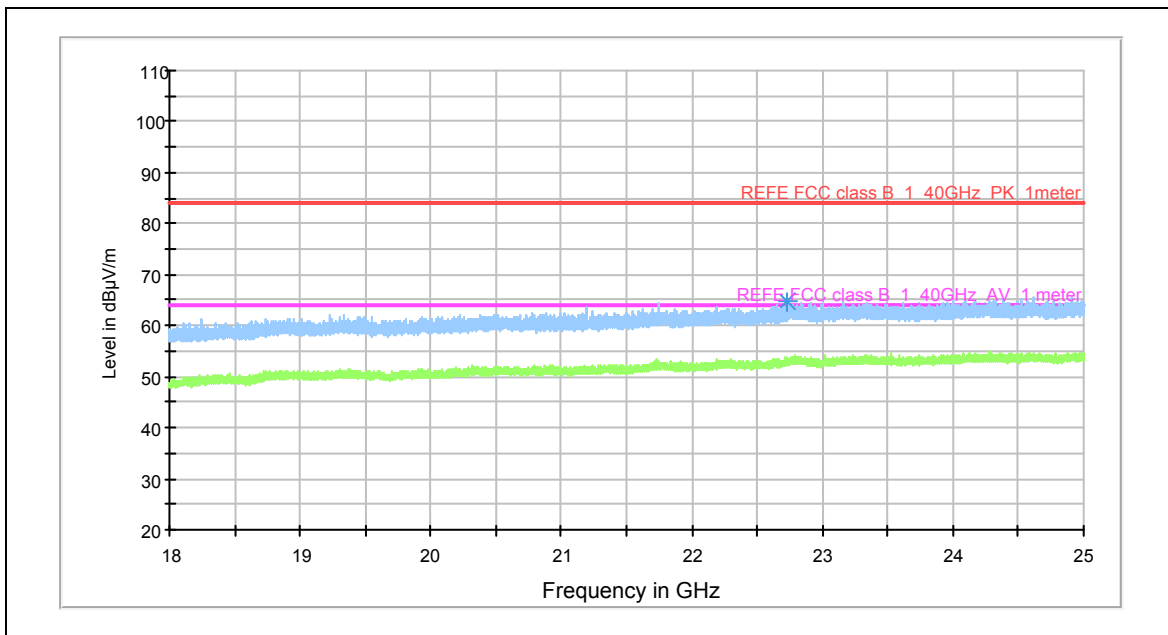

802.11b 1 Mbps Channel 6 : 18 GHz to 25 GHz

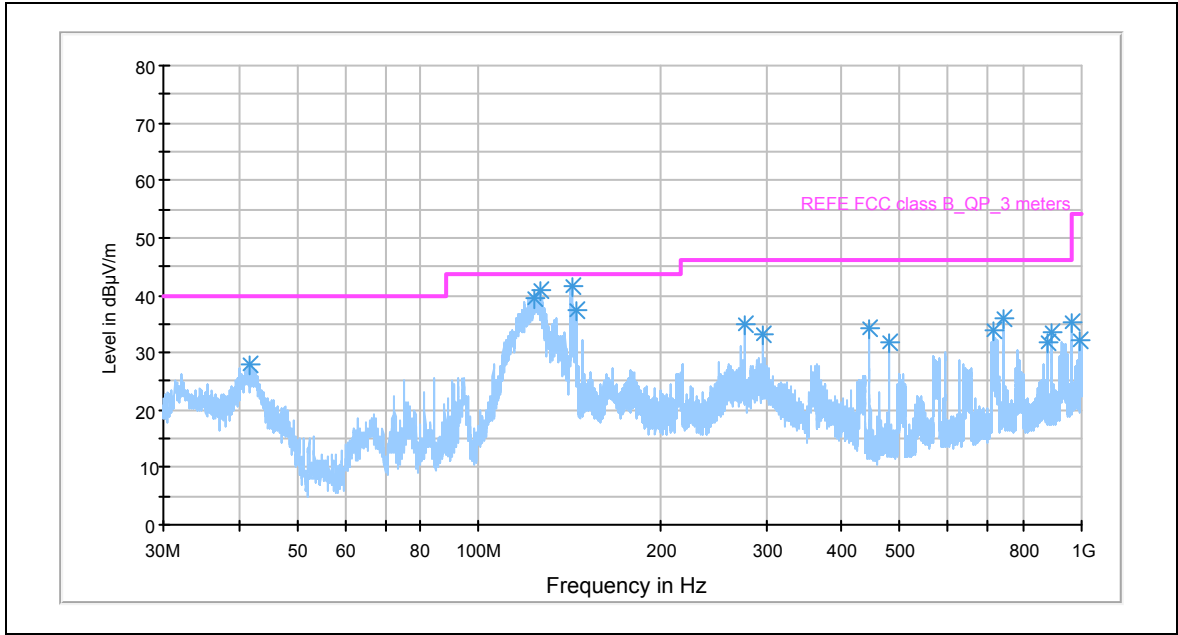

802.11b 1 Mbps Channel 11 : 30 MHz to 1 GHz

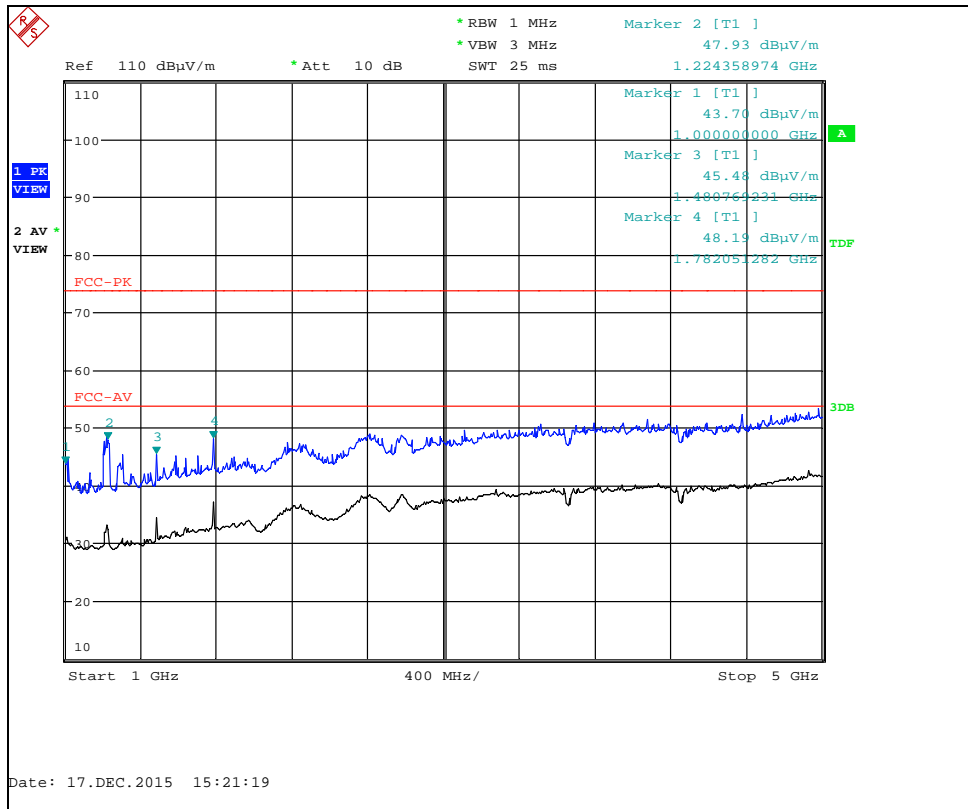

802.11b 1 Mbps Channel 11 : 1 GHz to 5 GHz

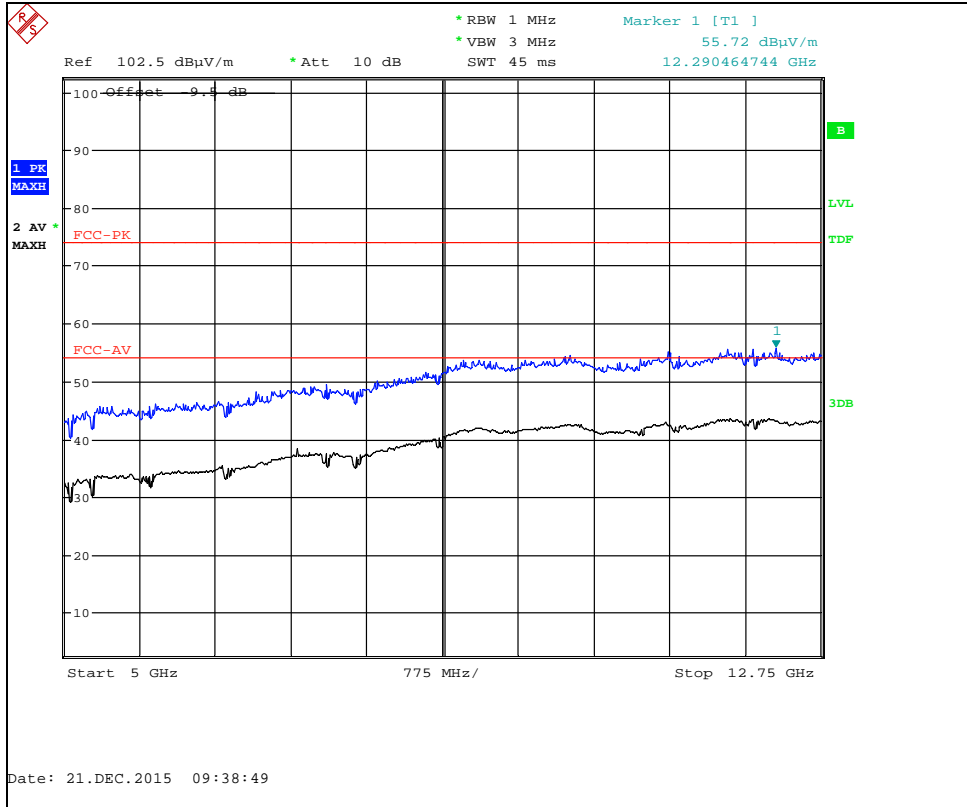

802.11b 1 Mbps Channel 11 : 5 GHz to 12.75 GHz

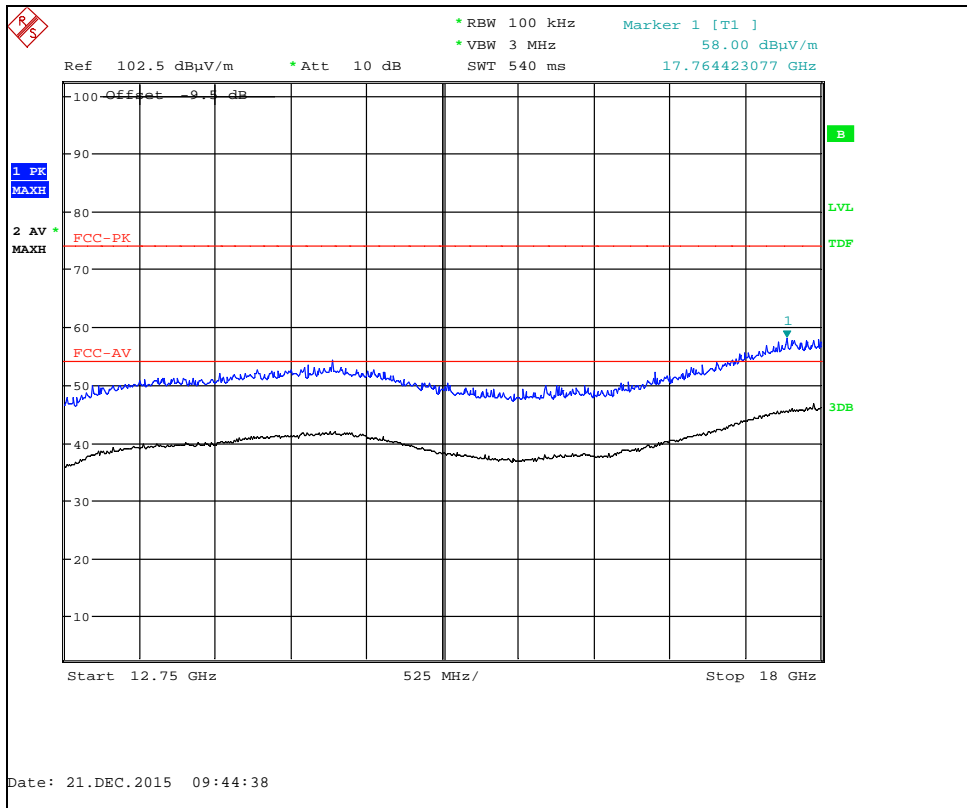

802.11b 1 Mbps Channel 11 : 12.75 GHz to 18 GHz

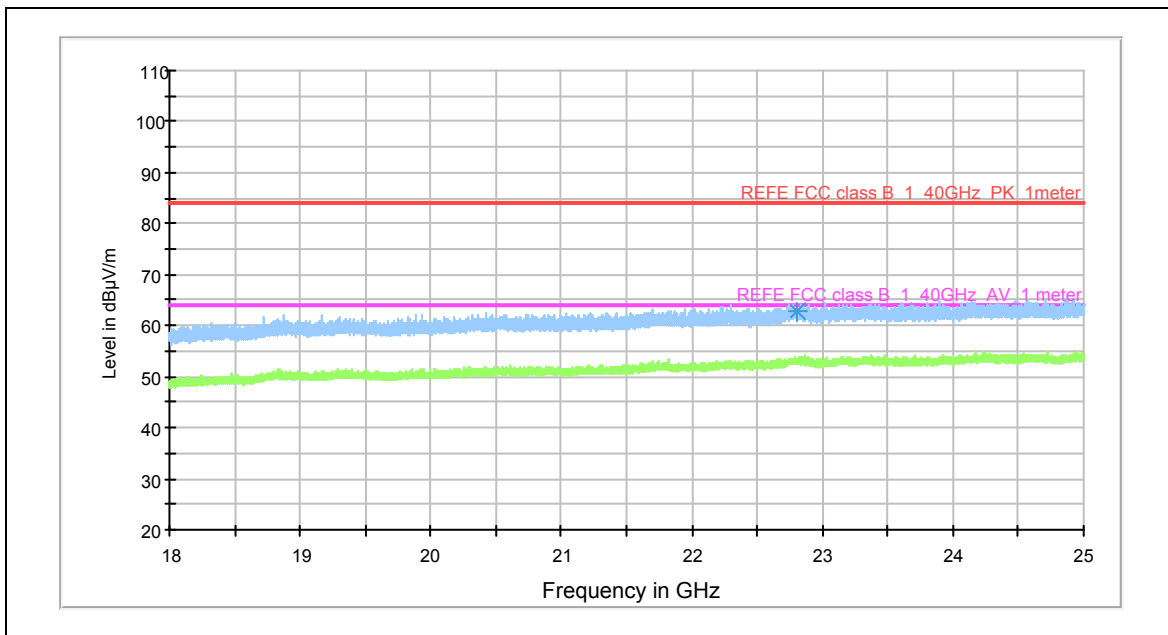

802.11b 1 Mbps Channel 11 : 18 GHz to 25 GHz

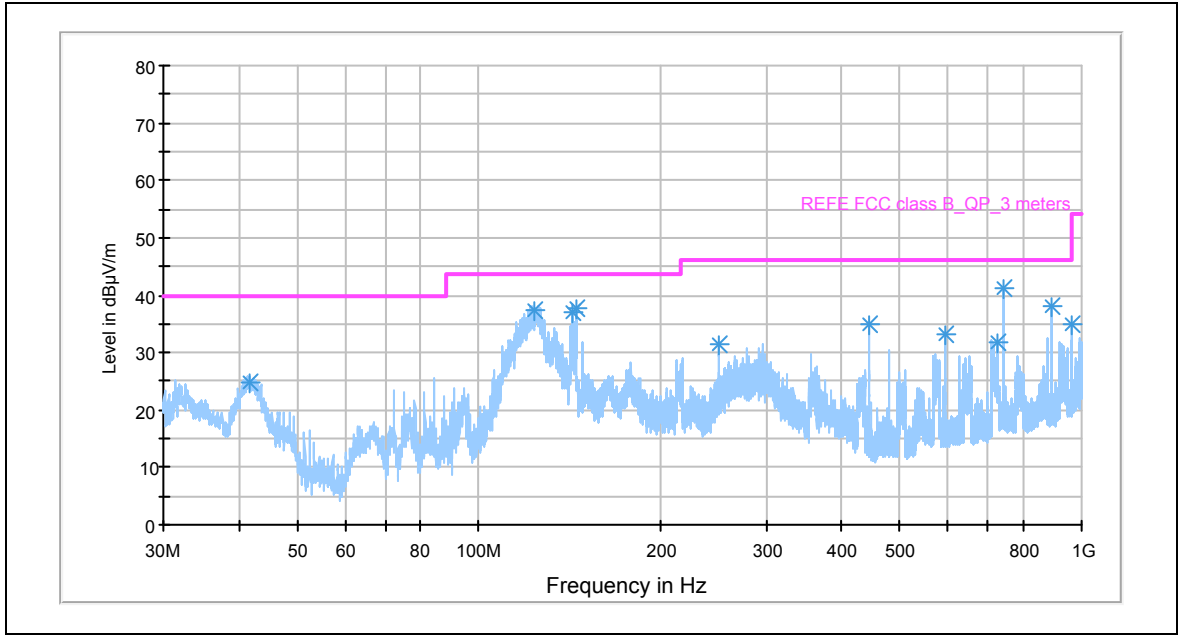

802.11b 11 Mbps Channel 1 : 30 MHz to 1 GHz

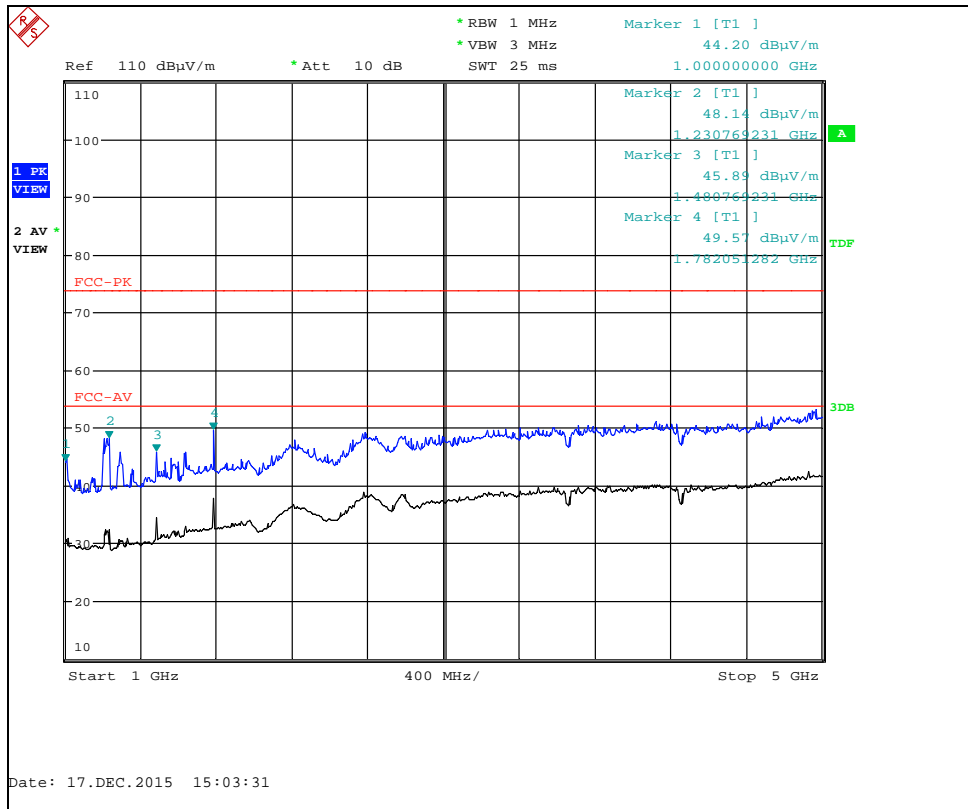

802.11b 11 Mbps Channel 1 : 1 GHz to 5 GHz

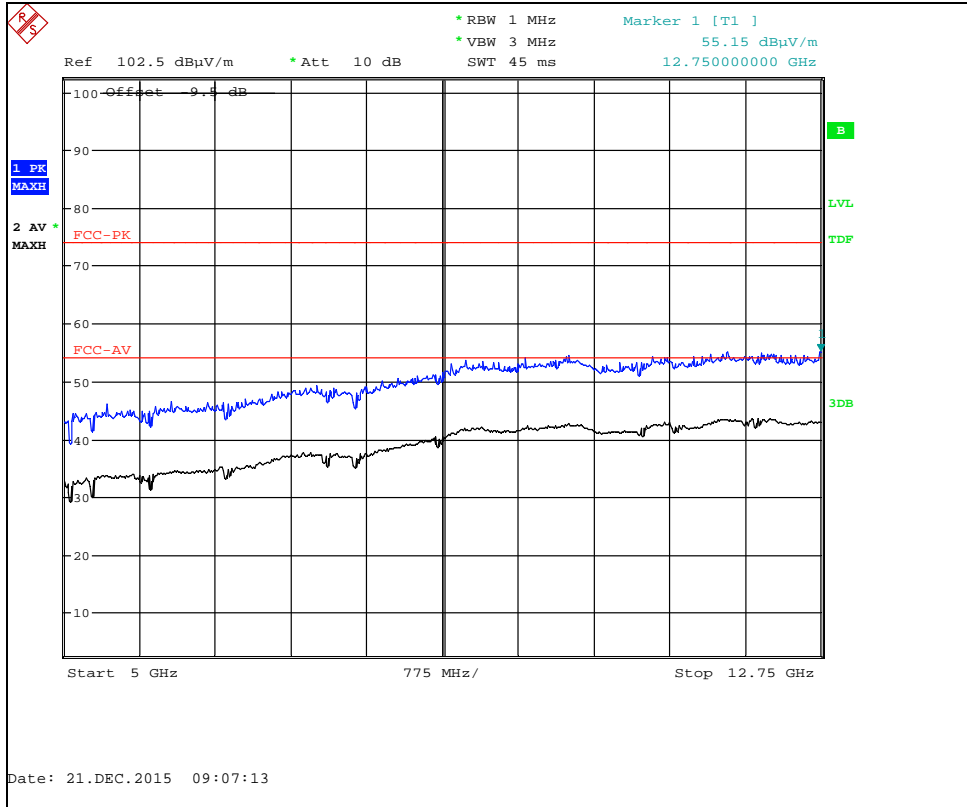

802.11b 11 Mbps Channel 1 : 5 GHz to 12.75 GHz

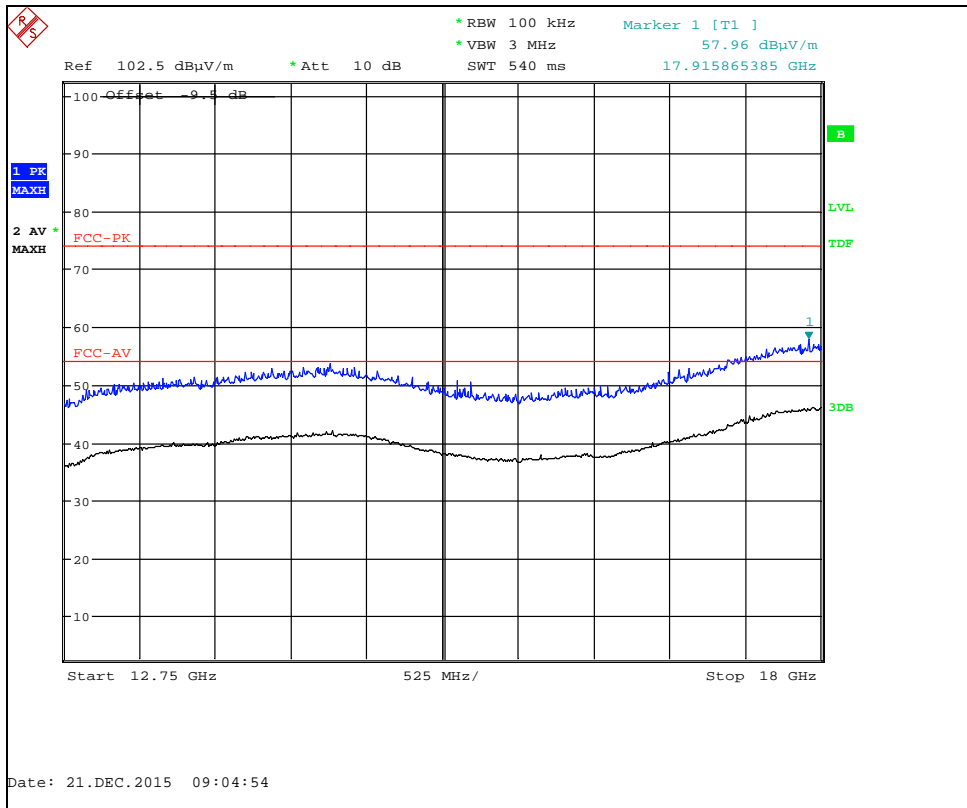

802.11b 11 Mbps Channel 1 : 12.75 GHz to 18 GHz

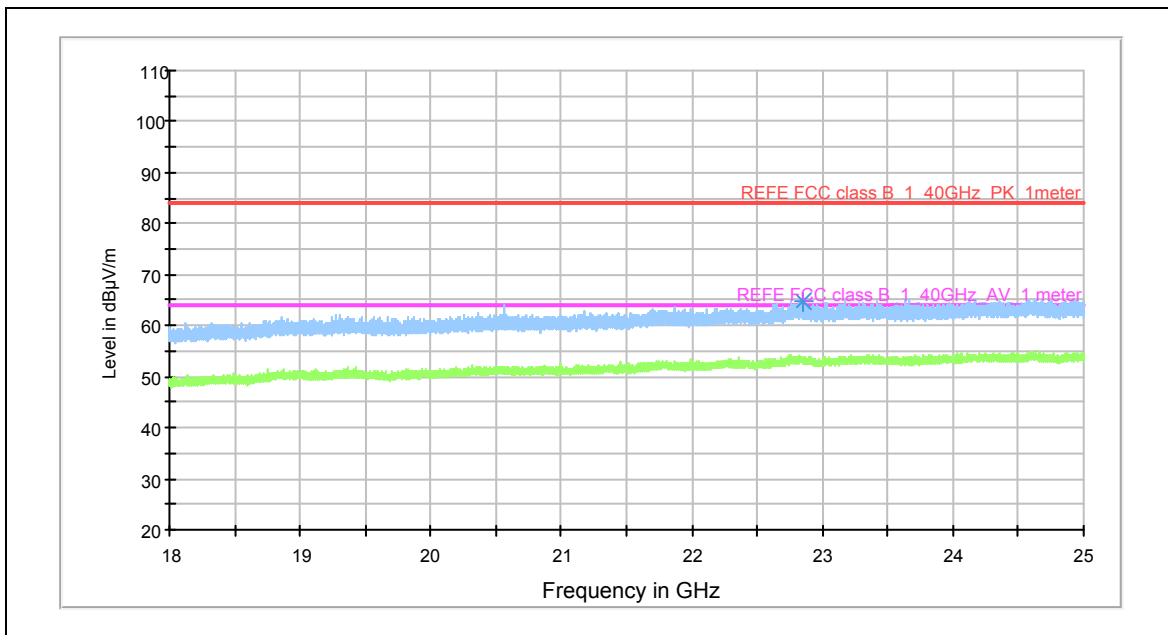

802.11b 11 Mbps Channel 1 : 18 GHz to 25 GHz

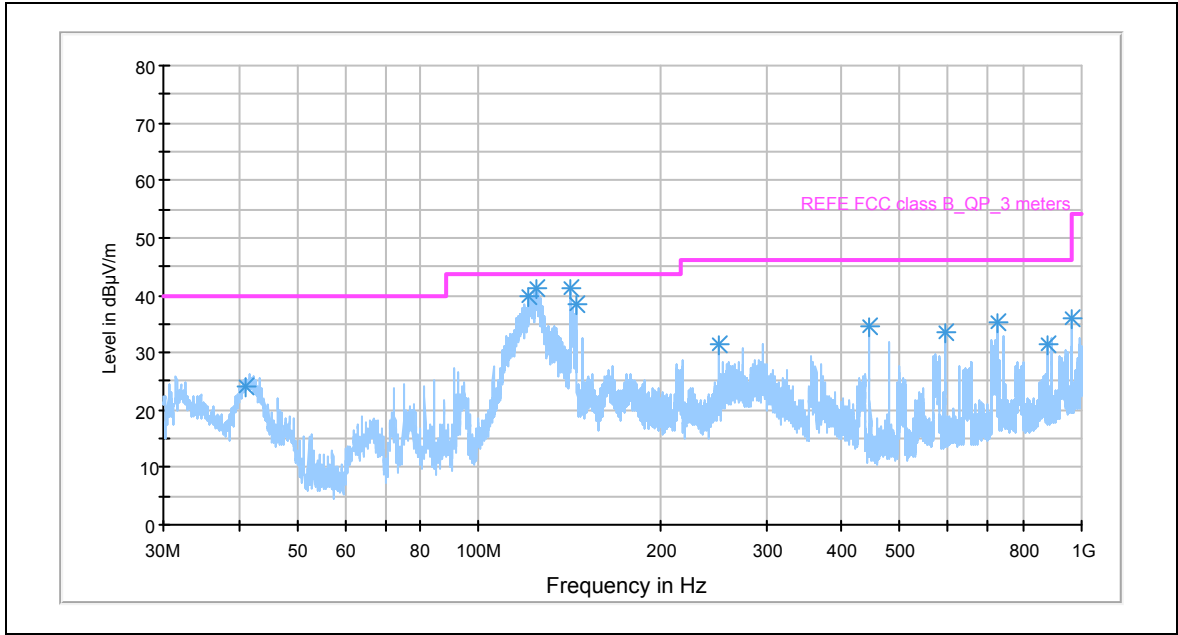

802.11b 11 Mbps Channel 6 : 30 MHz to 1 GHz

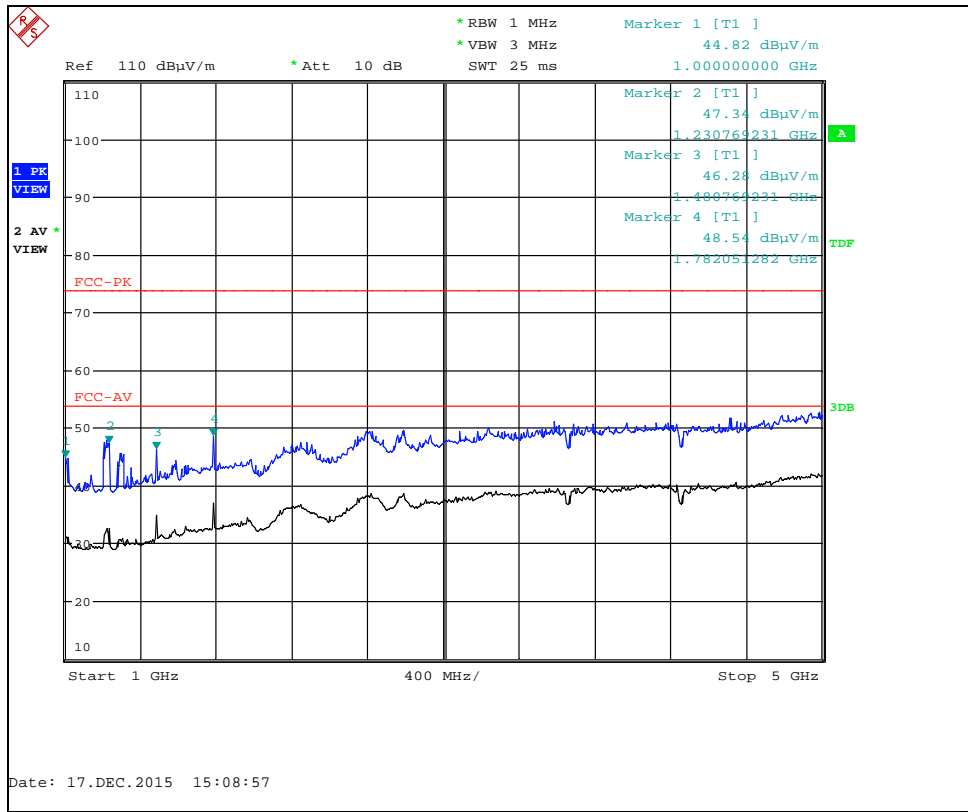

802.11b 11 Mbps Channel 6 : 1 GHz to 5 GHz

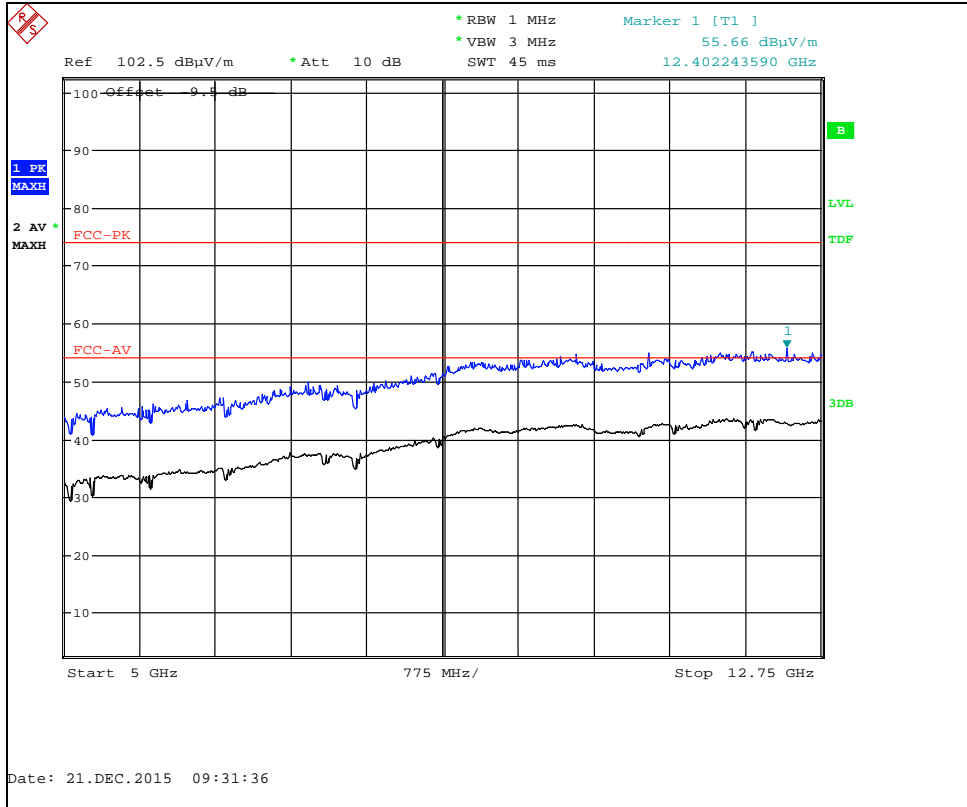

802.11b 11 Mbps Channel 6 : 5 GHz to 12.75 GHz

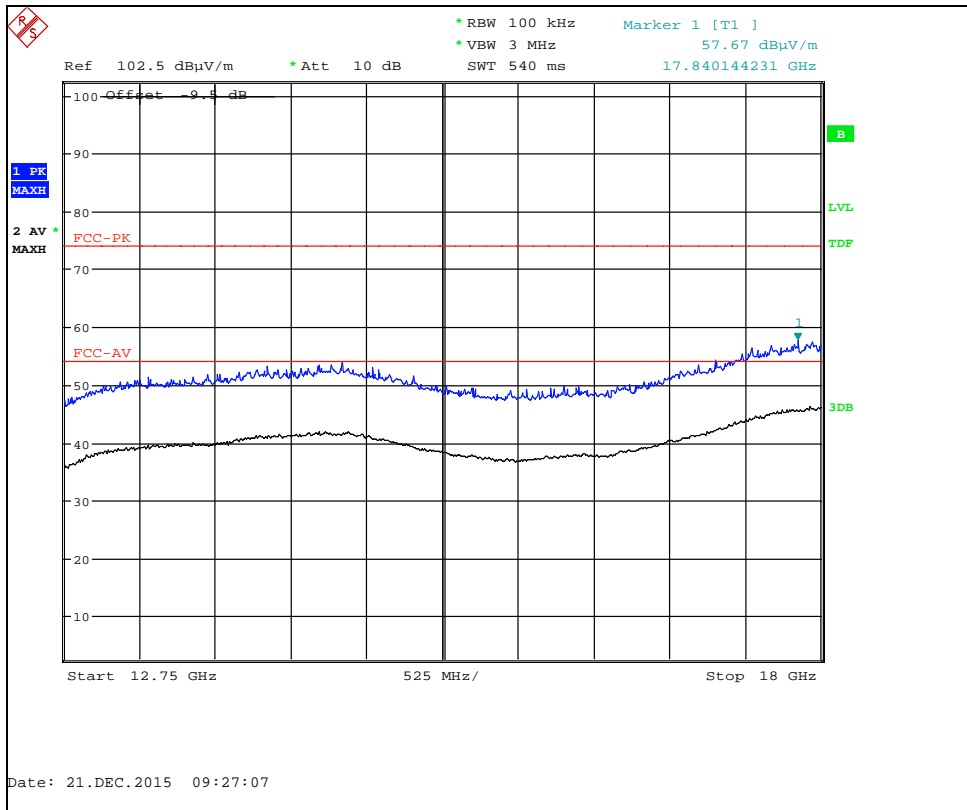

802.11b 11 Mbps Channel 6 : 12.75 GHz to 18 GHz

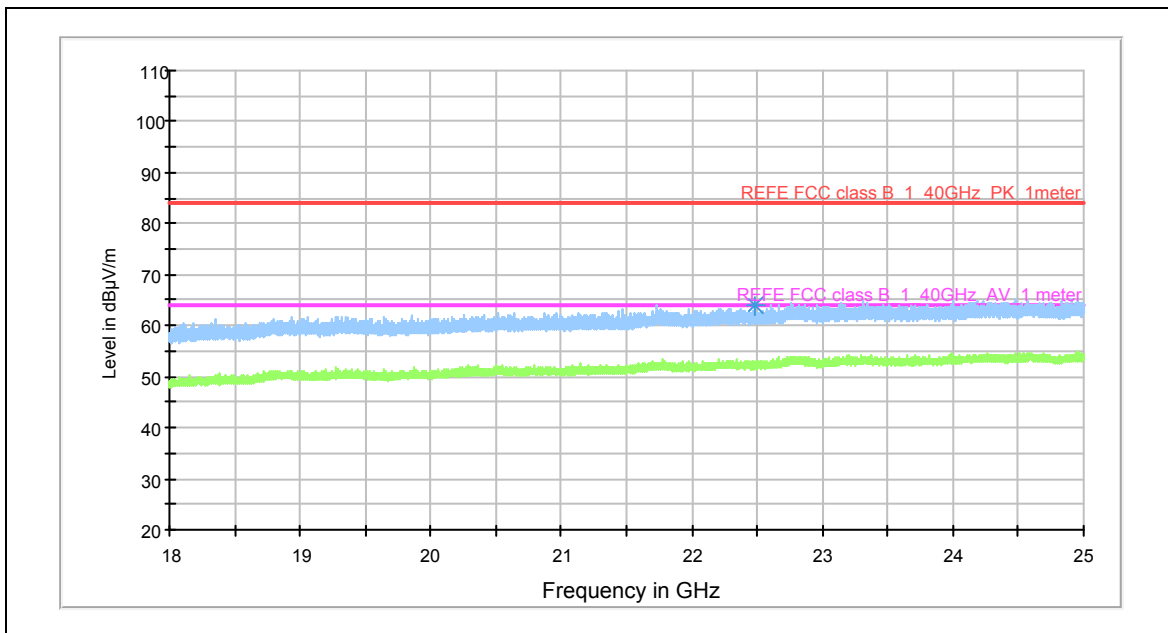

802.11b 11 Mbps Channel 6 : 18 GHz to 25 GHz

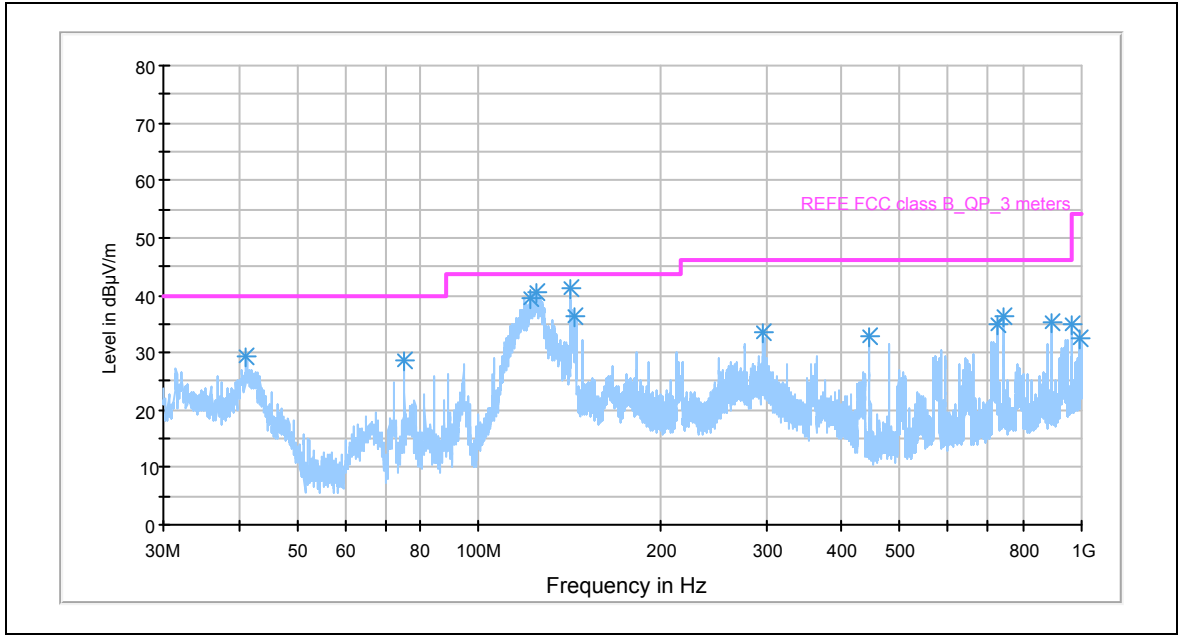

802.11b 11 Mbps Channel 11 : 30 MHz to 1 GHz

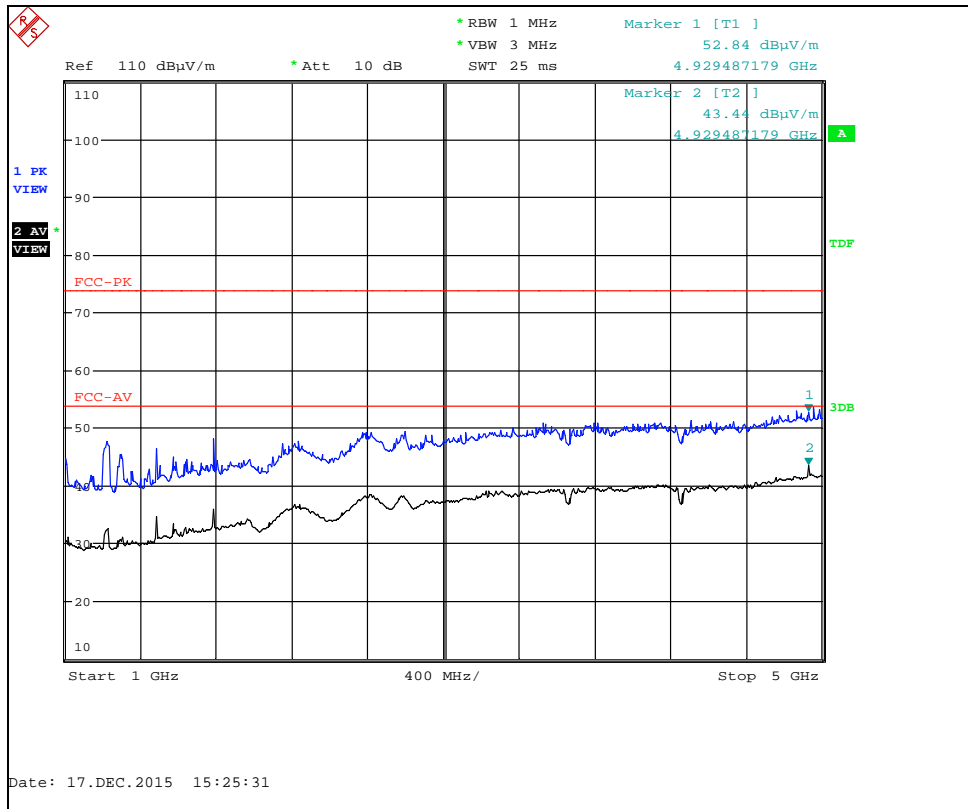

802.11b 11 Mbps Channel 11 : 1 GHz to 5 GHz

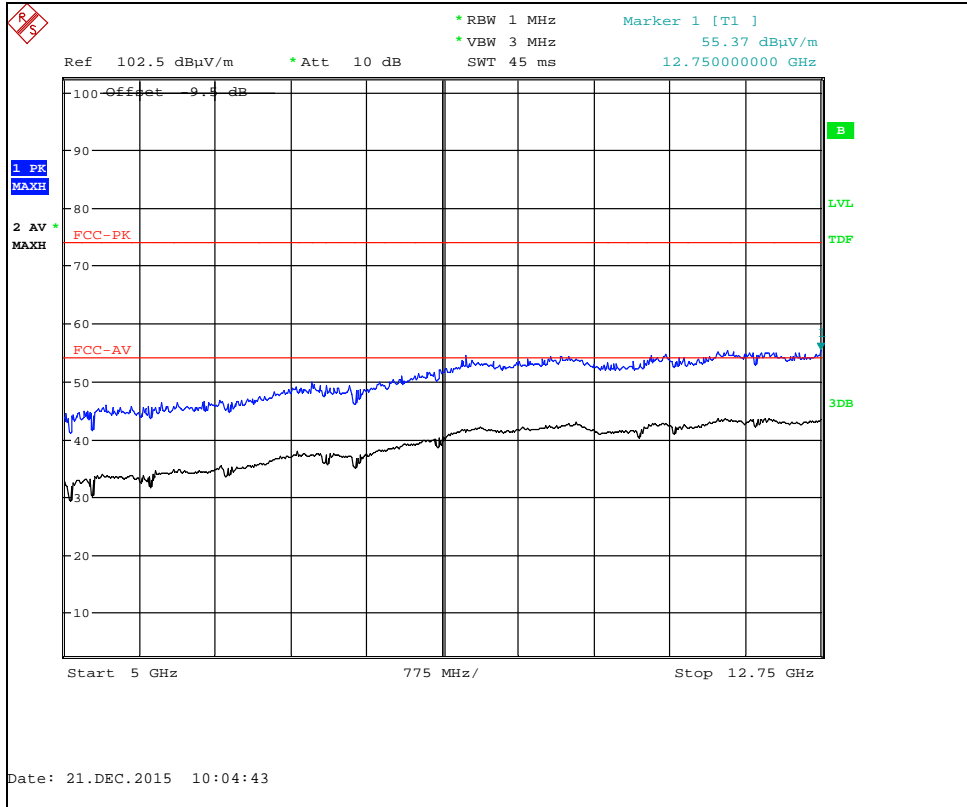

802.11b 11 Mbps Channel 11 : 5 GHz to 12.75 GHz

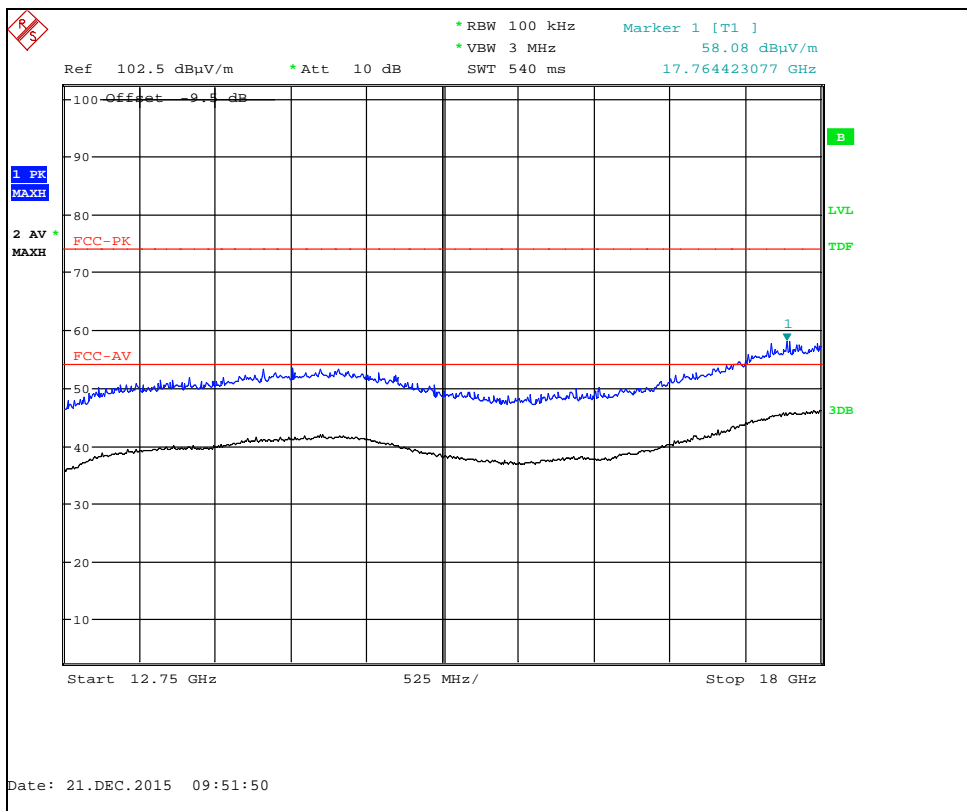

802.11b 11 Mbps Channel 11 : 12.75 GHz to 18 GHz

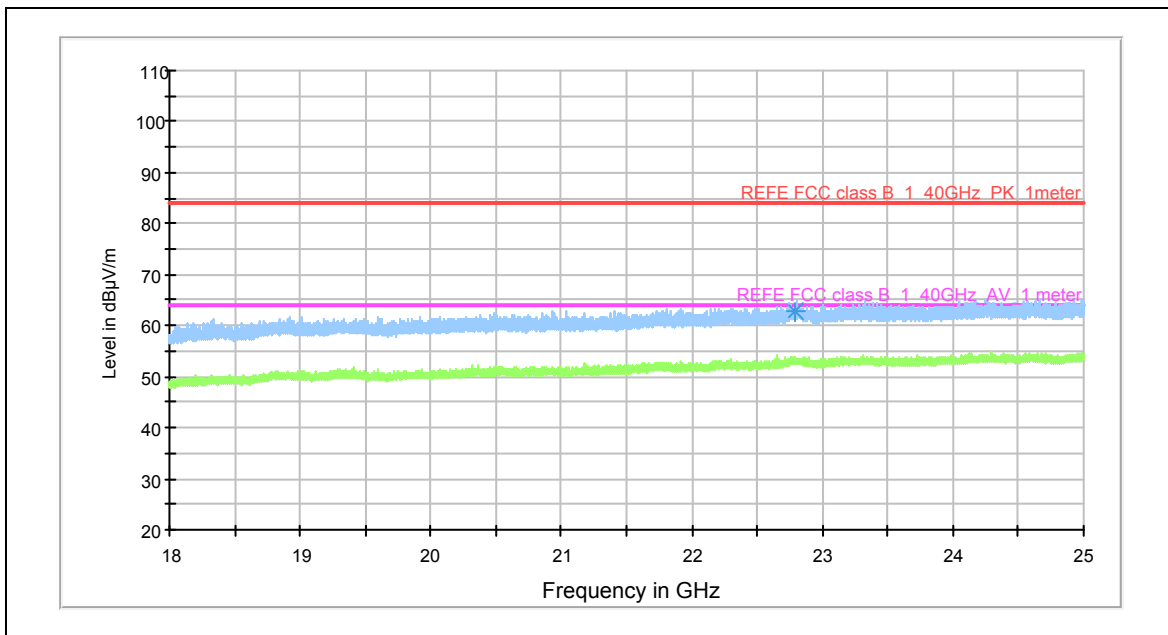

802.11b 11 Mbps Channel 11 : 18 GHz to 25 GHz

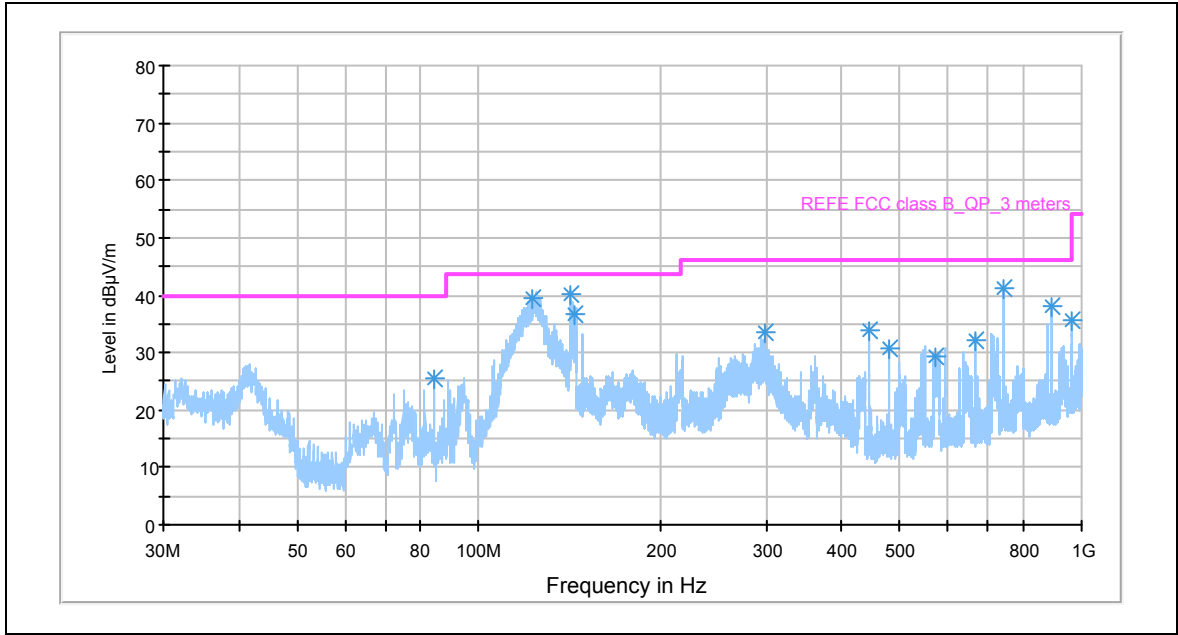

802.11g 6 Mbps Channel 1 : 30 MHz to 1 GHz

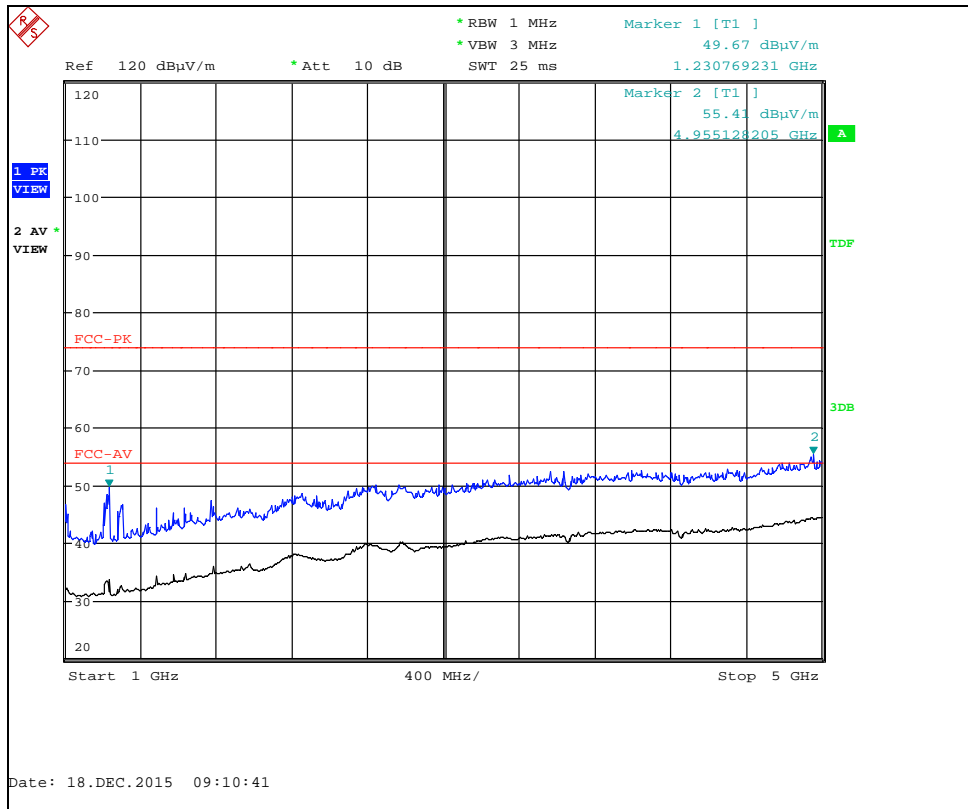

802.11g 6 Mbps Channel 1 : 1 GHz to 5 GHz

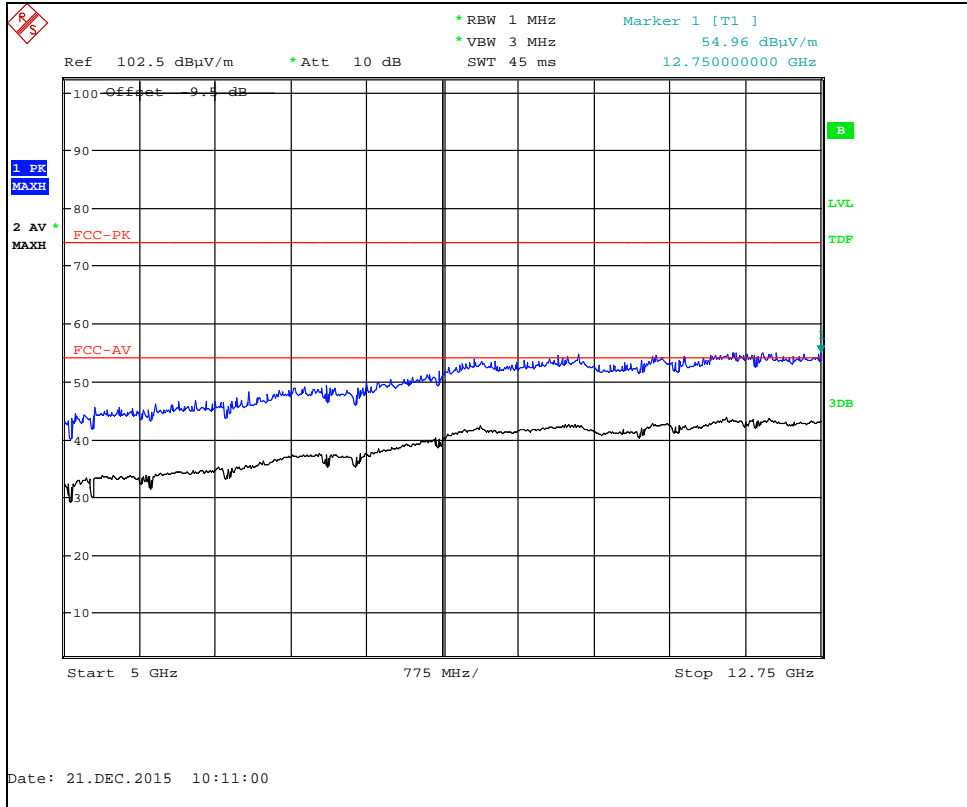

802.11g 6 Mbps Channel 1 : 5 GHz to 12.75 GHz

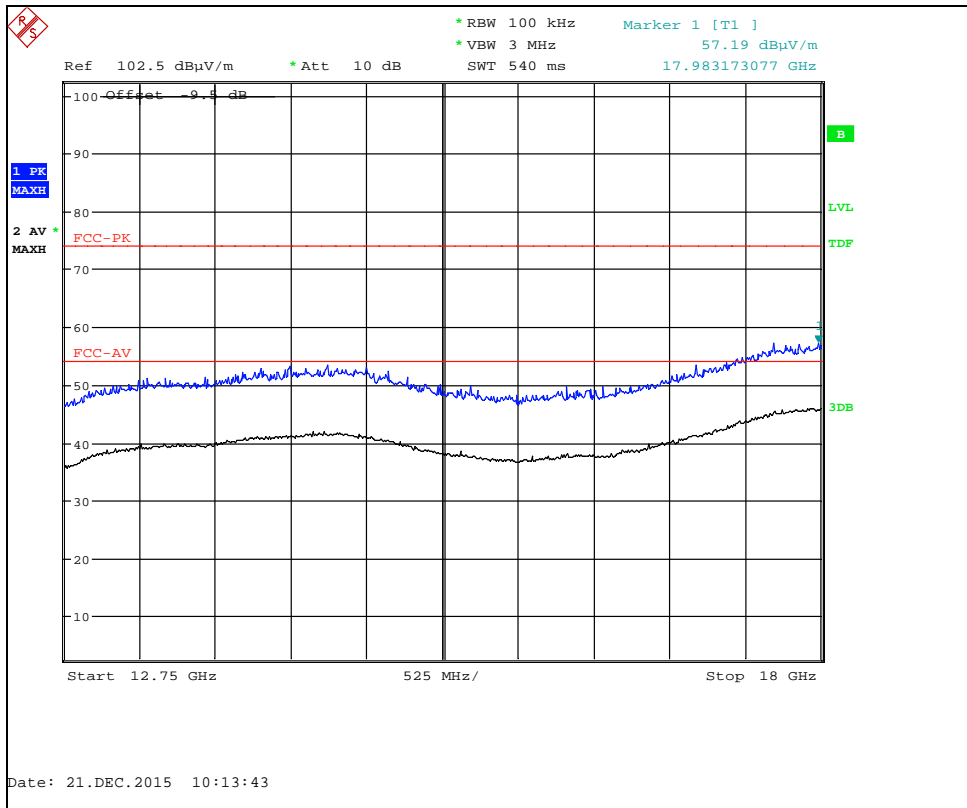

802.11g 6 Mbps Channel 1 : 12.75 GHz to 18 GHz

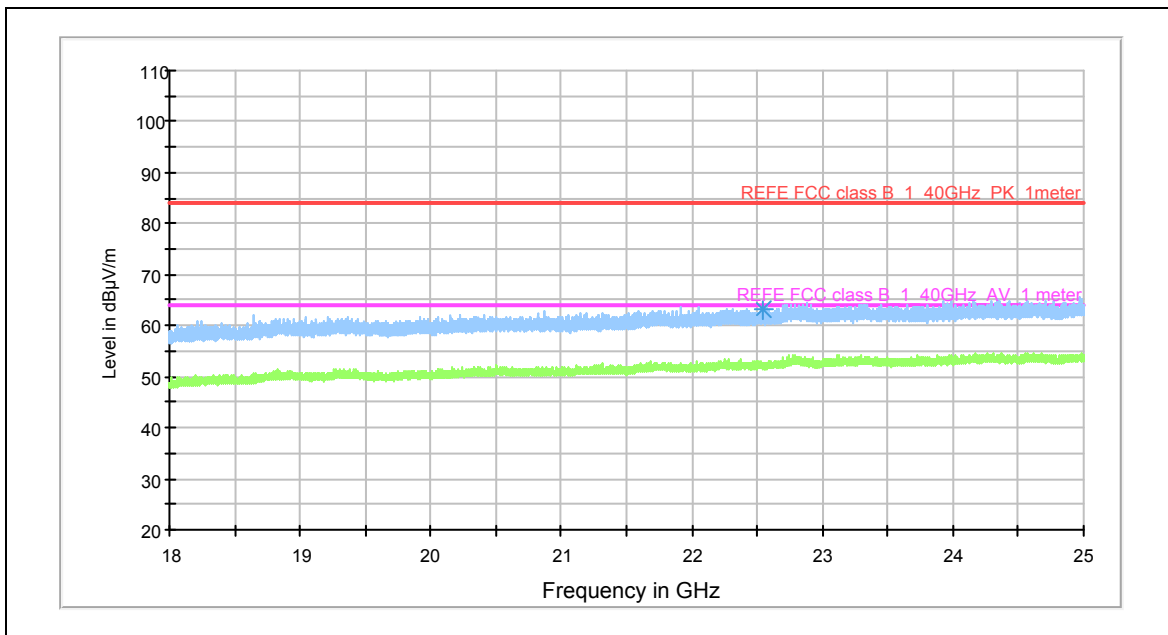

802.11g 6 Mbps Channel 1 : 18 GHz to 25 GHz

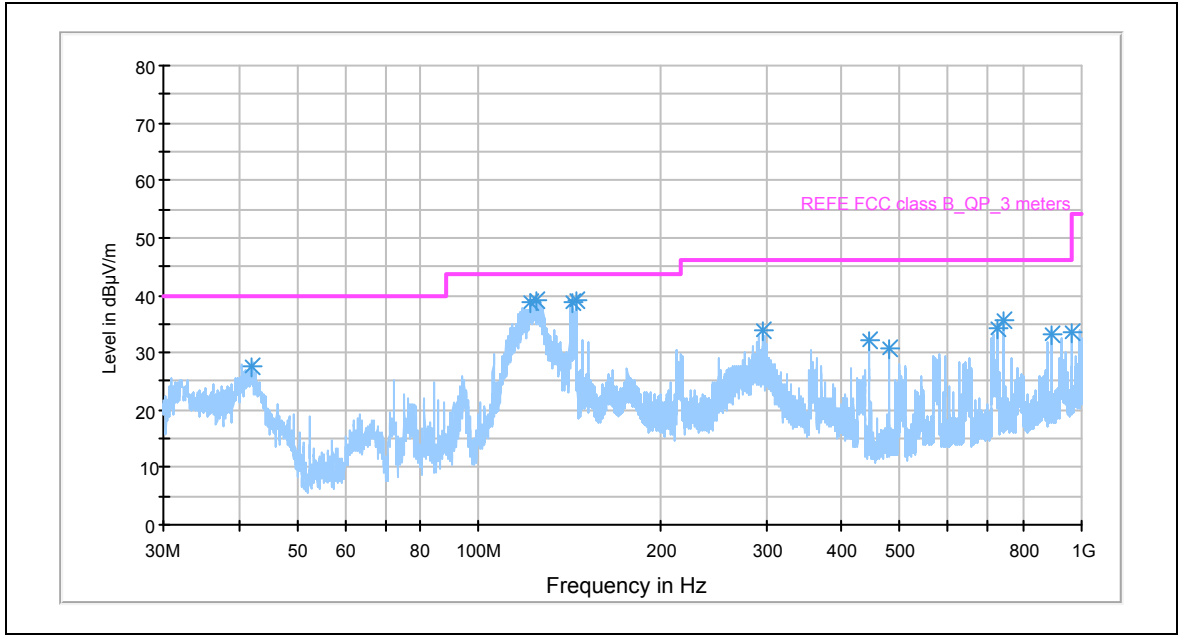

802.11g 6 Mbps Channel 6 : 30 MHz to 1 GHz

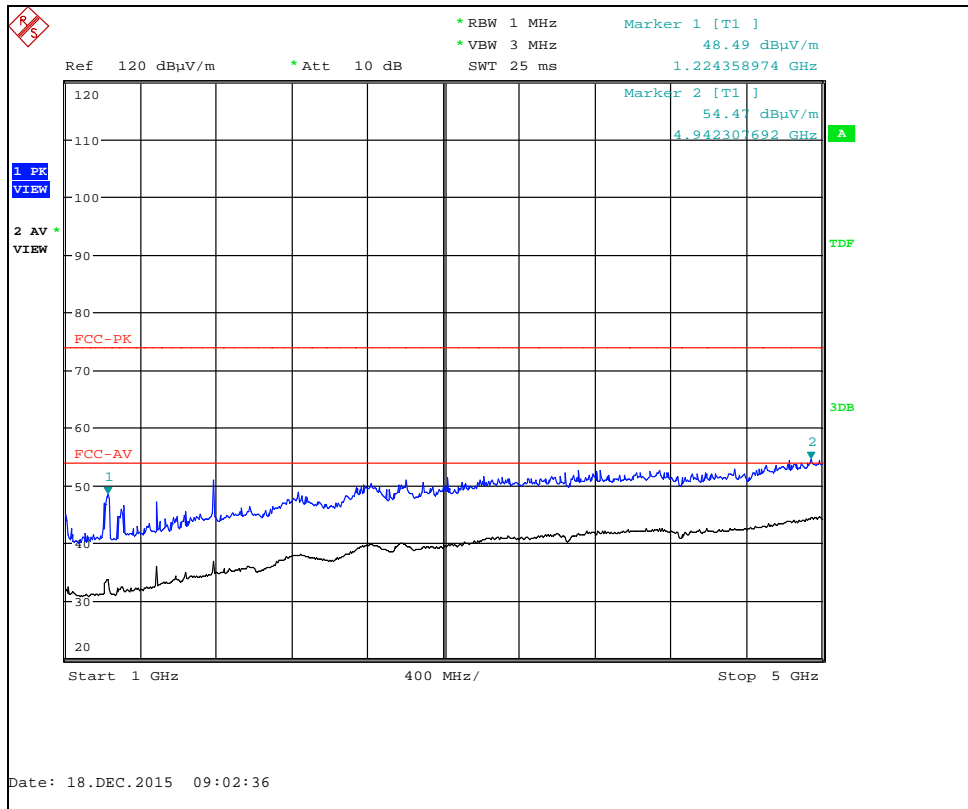

802.11g 6 Mbps Channel 6 : 1 GHz to 5 GHz

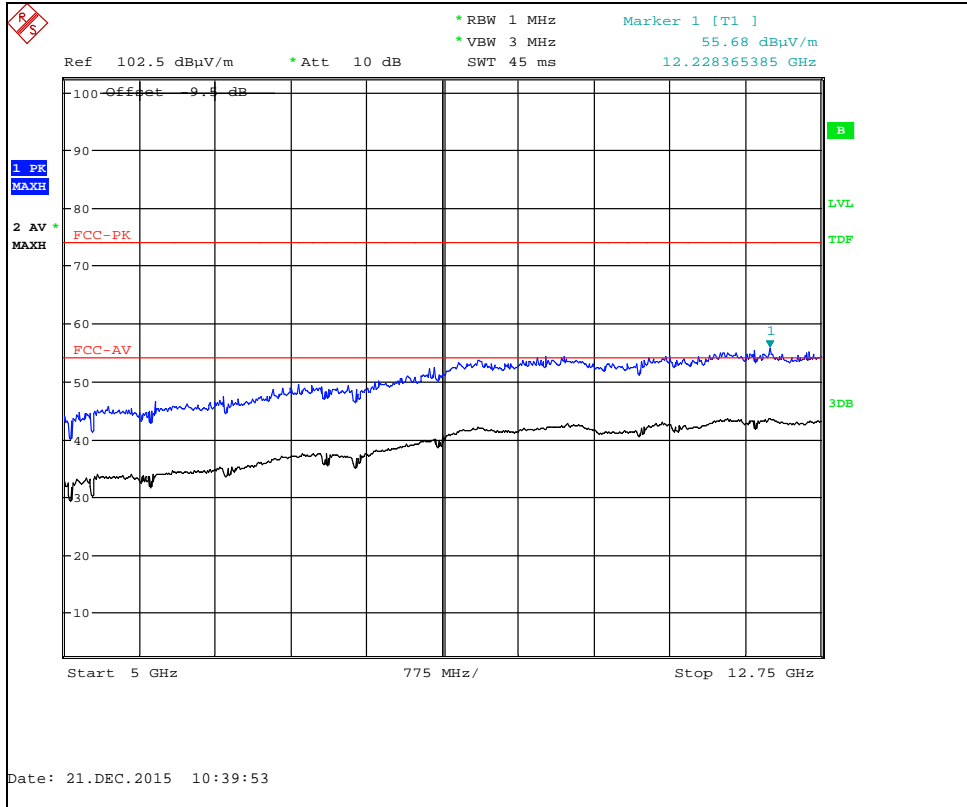

802.11g 6 Mbps Channel 6 : 5 GHz to 12.75 GHz

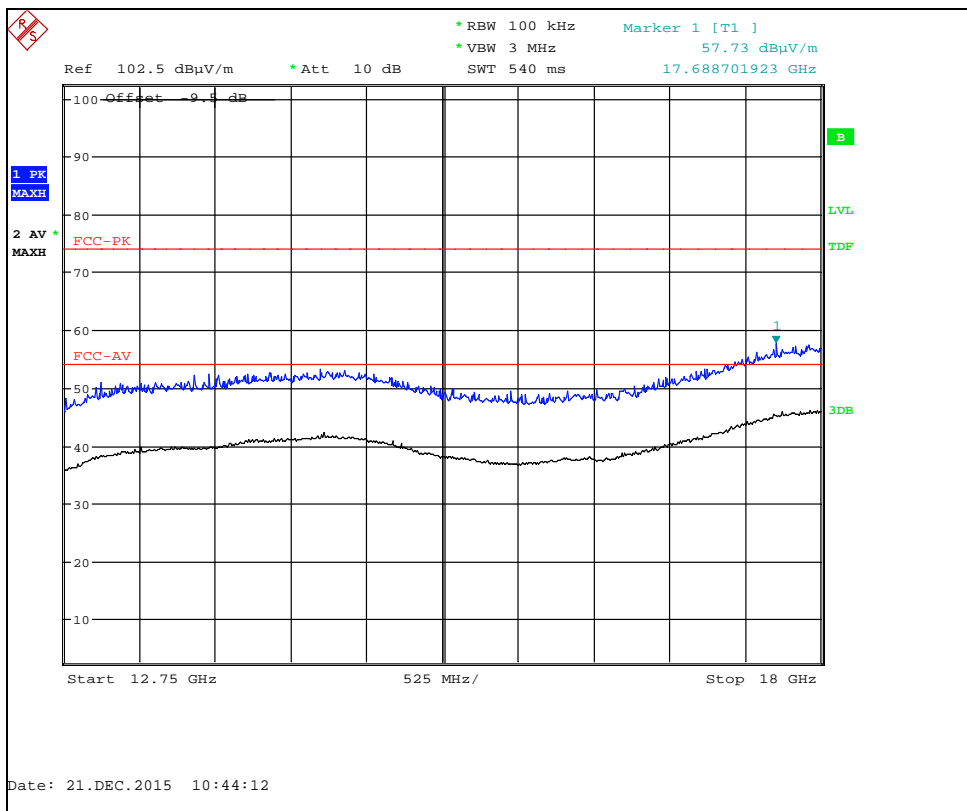

802.11g 6 Mbps Channel 6 : 12.75 GHz to 18 GHz

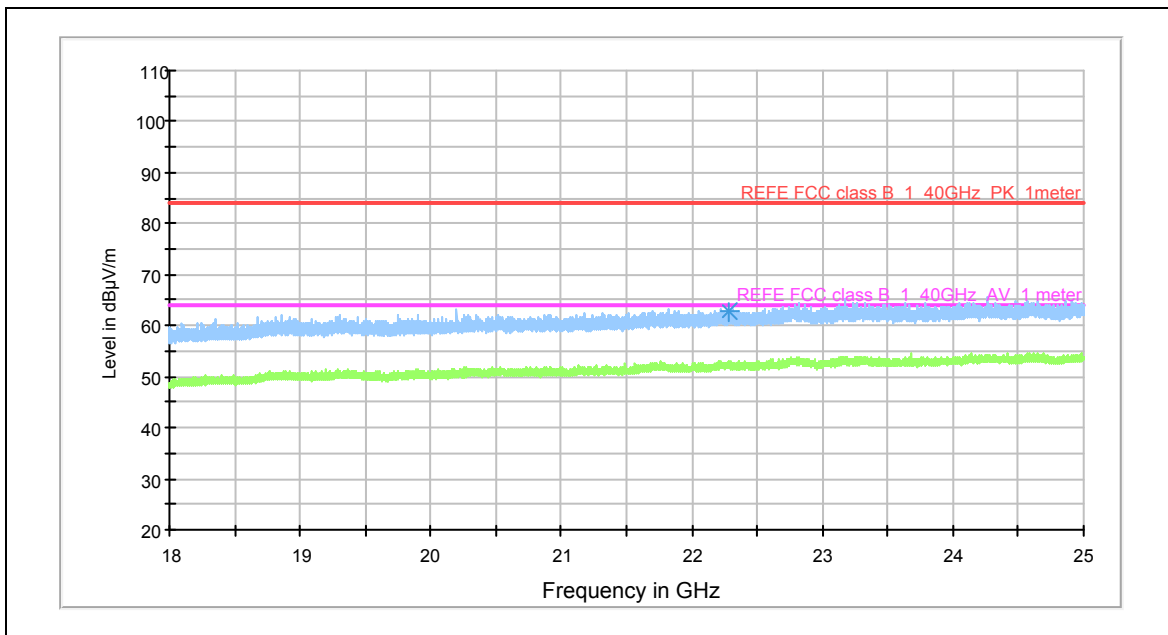

802.11g 6 Mbps Channel 6 : 18 GHz to 25 GHz

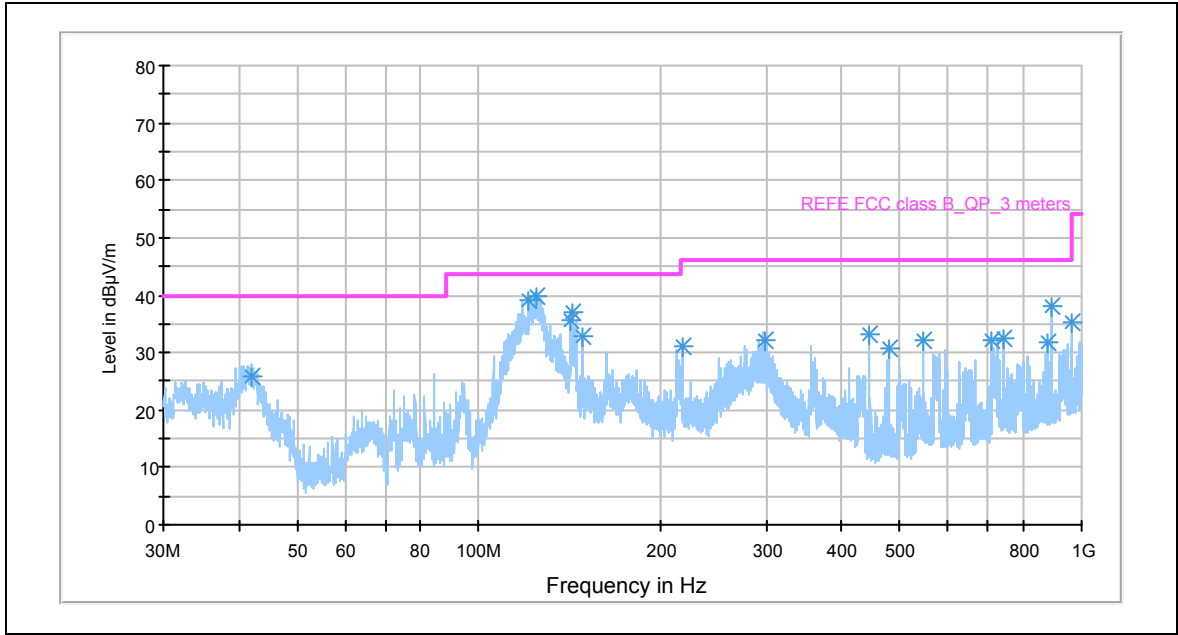

802.11g 6 Mbps Channel 11 : 30 MHz to 1 GHz

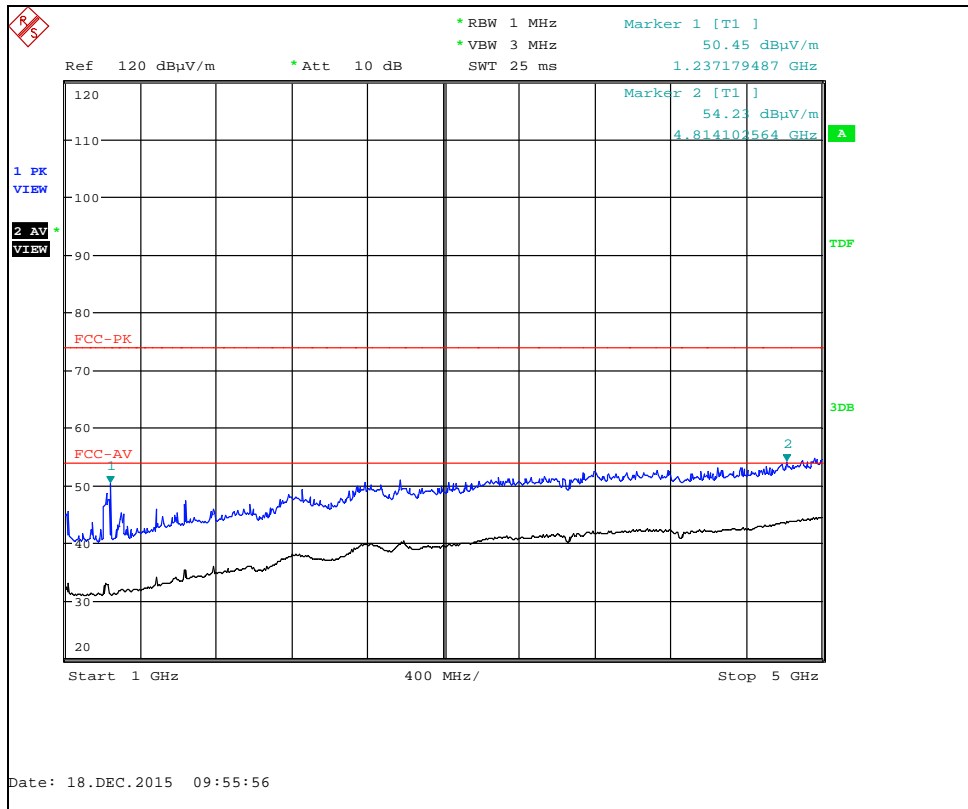

802.11g 6 Mbps Channel 11 : 1 GHz to 5 GHz

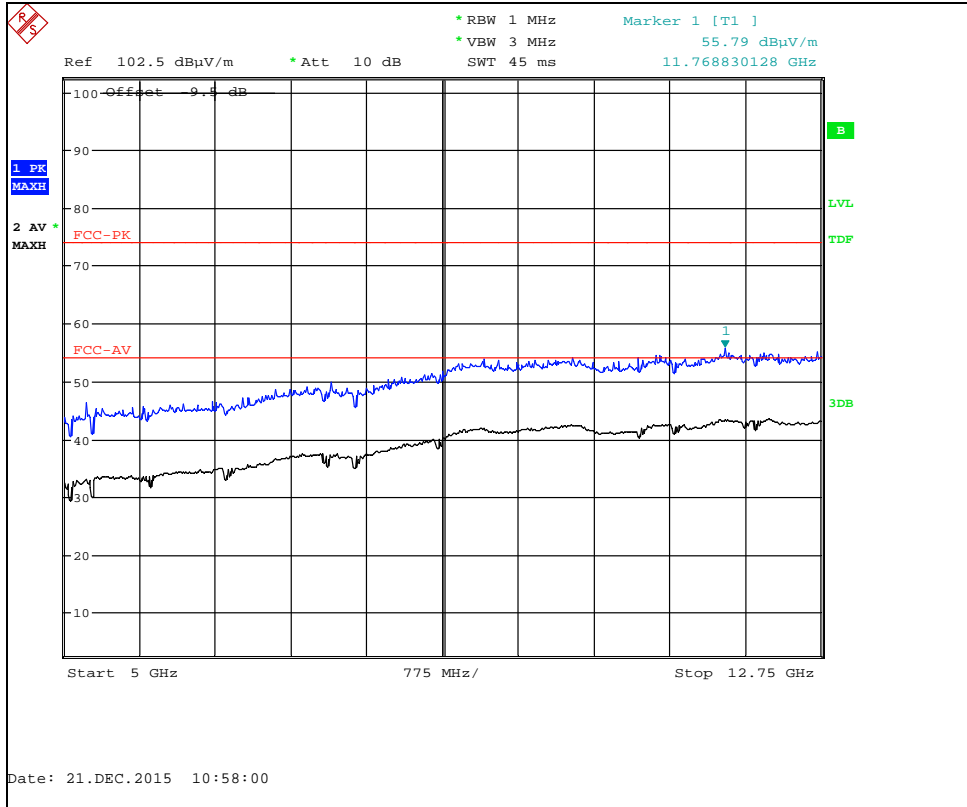

802.11g 6 Mbps Channel 11 : 5 GHz to 12.75 GHz

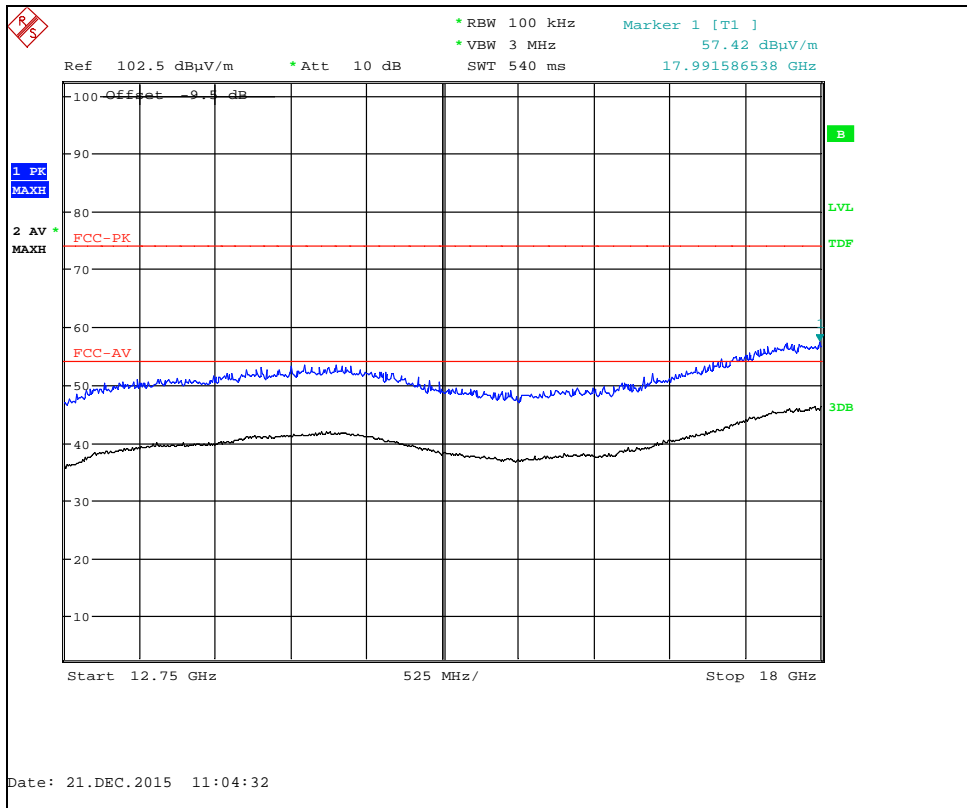

802.11g 6 Mbps Channel 11 : 12.75 GHz to 18 GHz

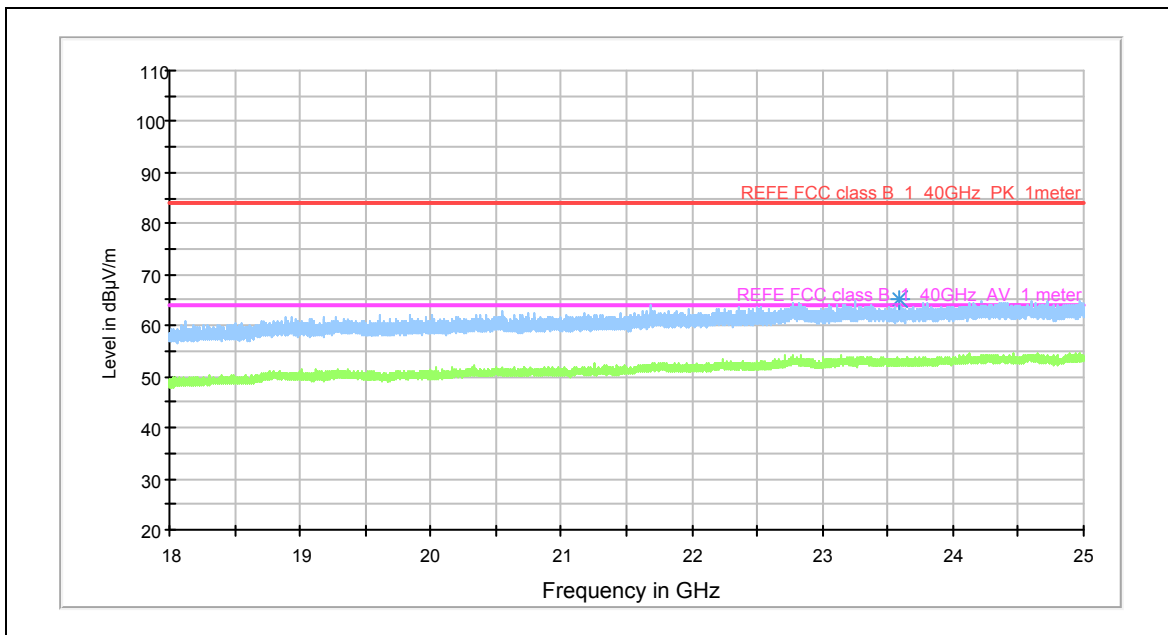

802.11g 6 Mbps Channel 11 : 18 GHz to 25 GHz

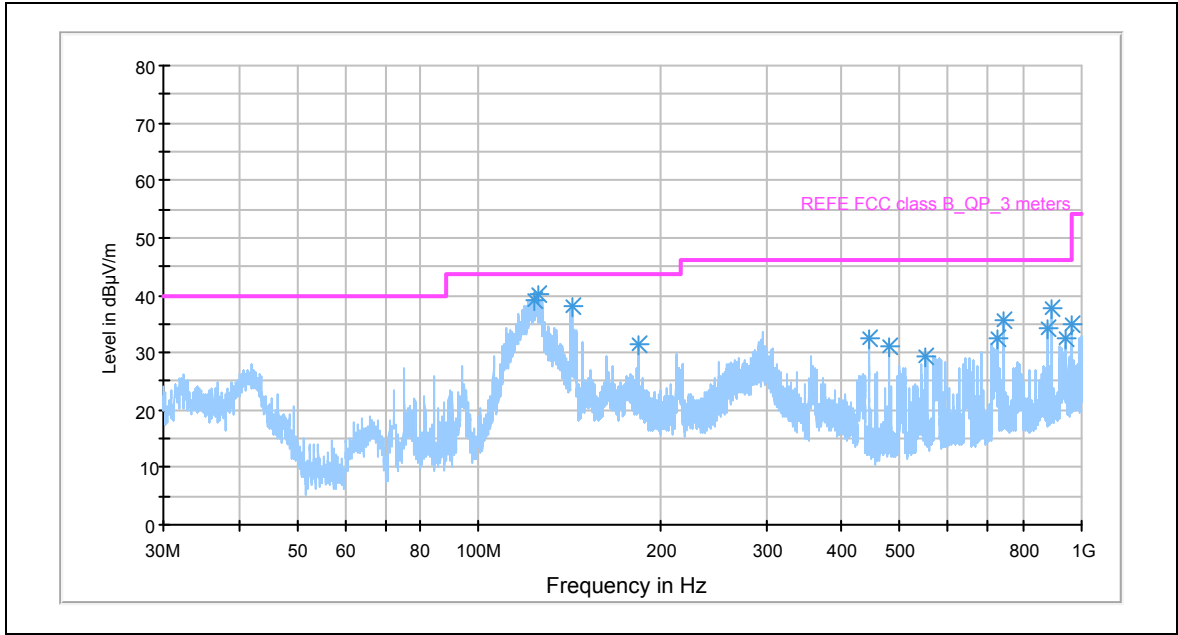

802.11g 54 Mbps Channel 1 : 30 MHz to 1 GHz

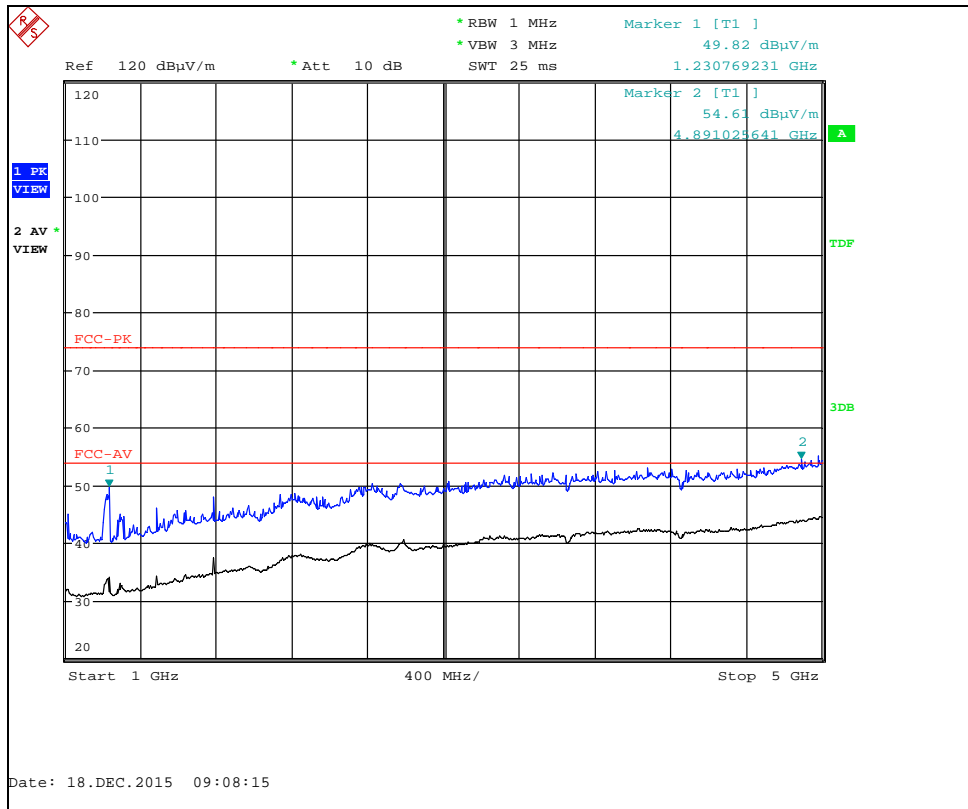

802.11g 54 Mbps Channel 1 : 1 GHz to 5 GHz

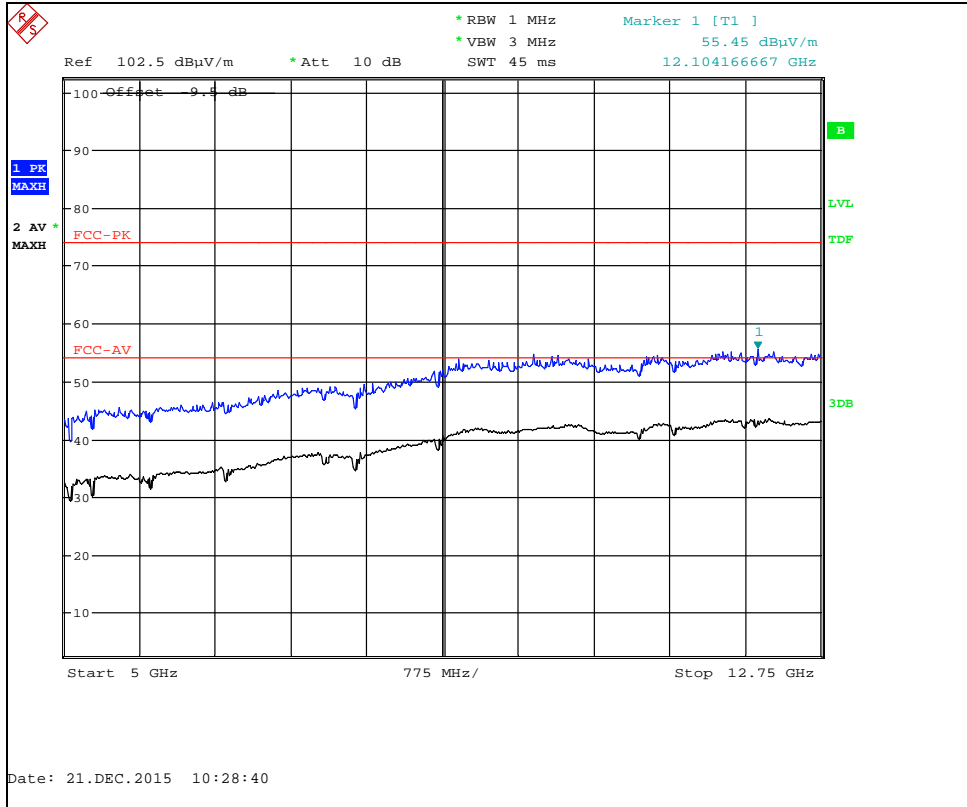

802.11g 54 Mbps Channel 1 : 5 GHz to 12.75 GHz

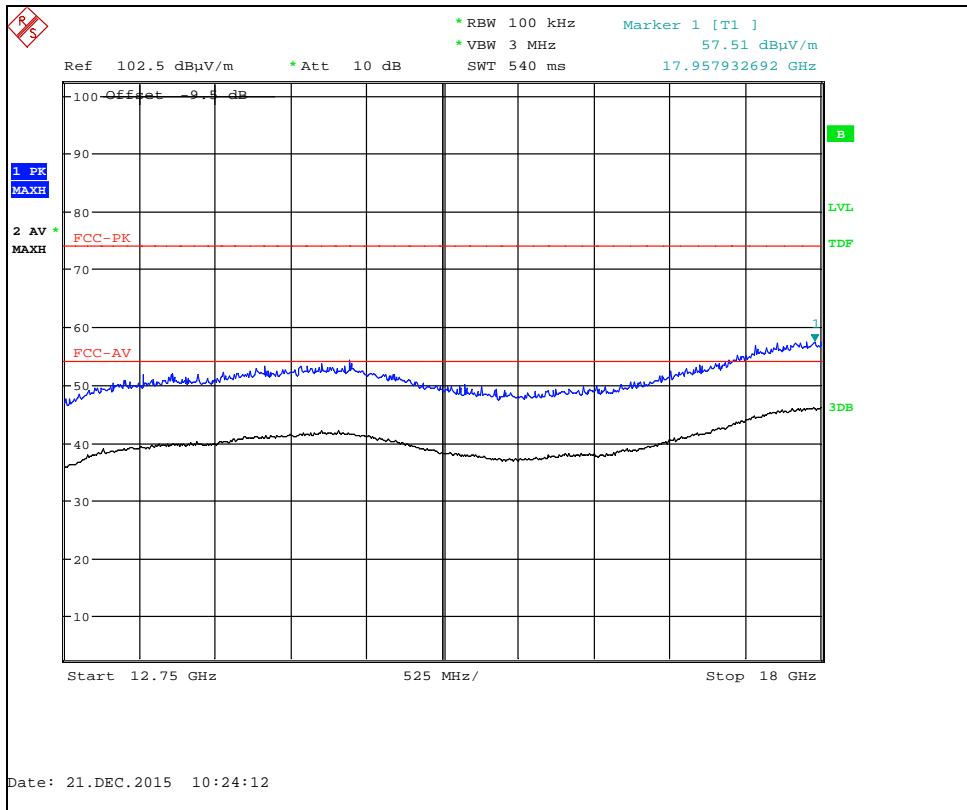

802.11g 54 Mbps Channel 1 : 12.75 GHz to 18 GHz

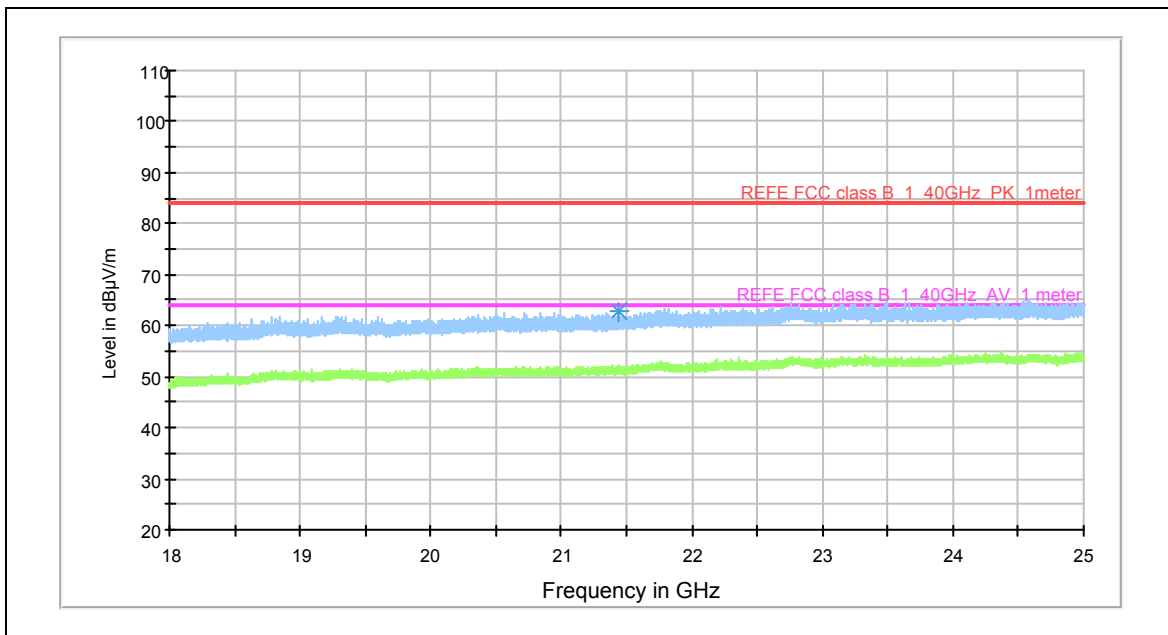

802.11g 54 Mbps Channel 1 : 18 GHz to 25 GHz

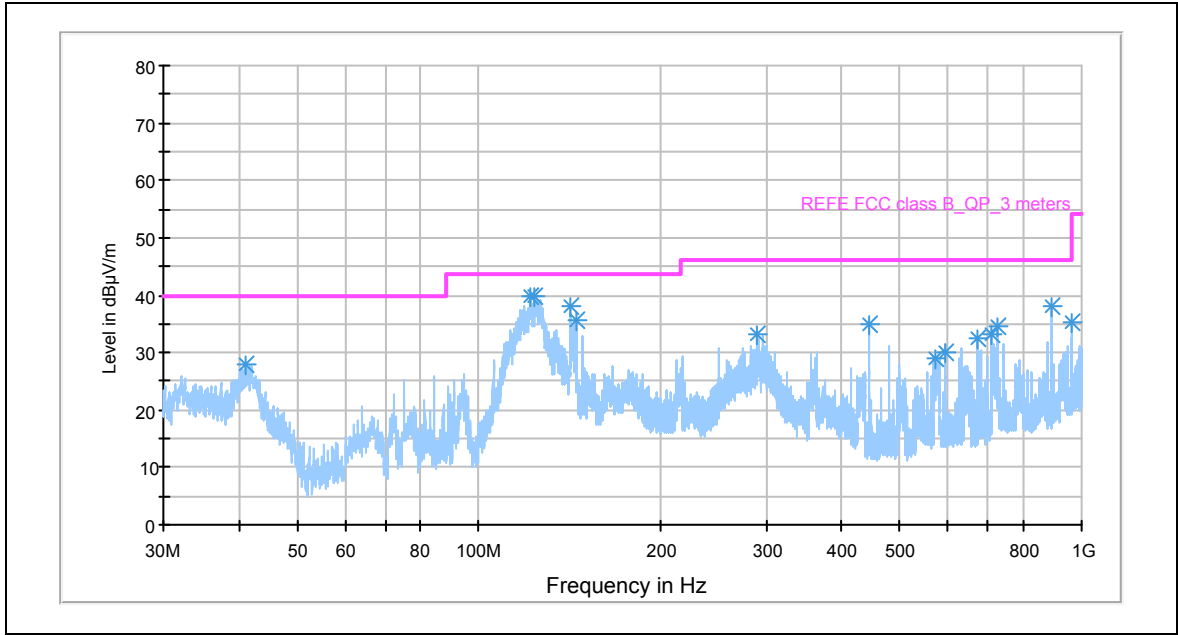

802.11g 54 Mbps Channel 6 : 30 MHz to 1 GHz

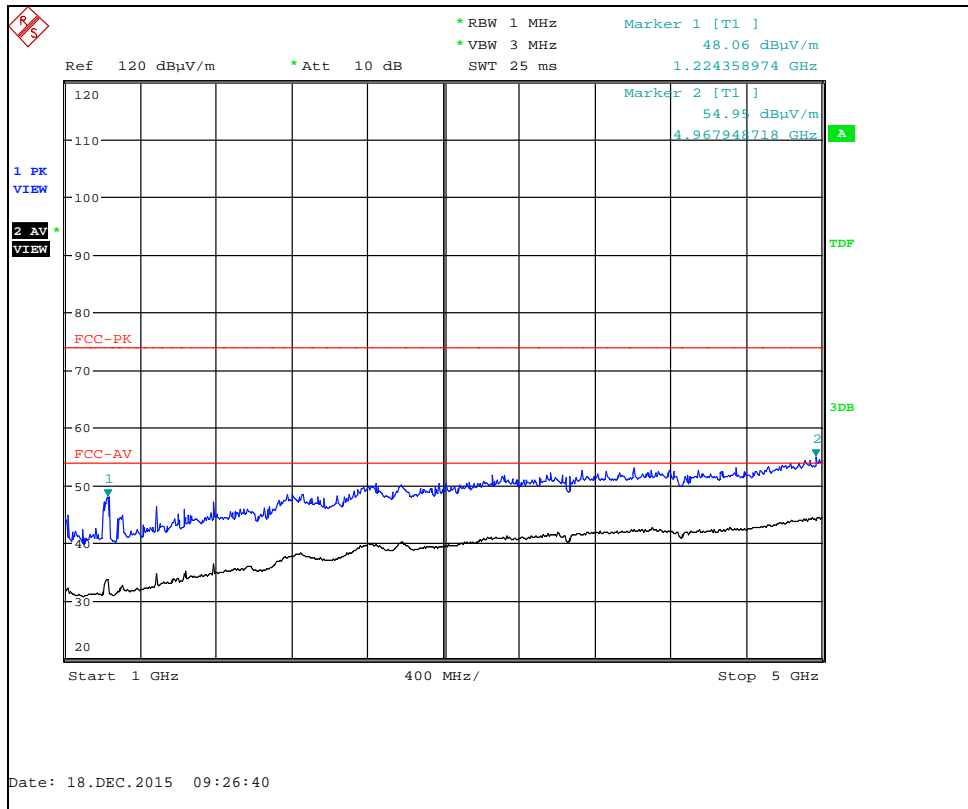

802.11g 54 Mbps Channel 6 : 1 GHz to 5 GHz

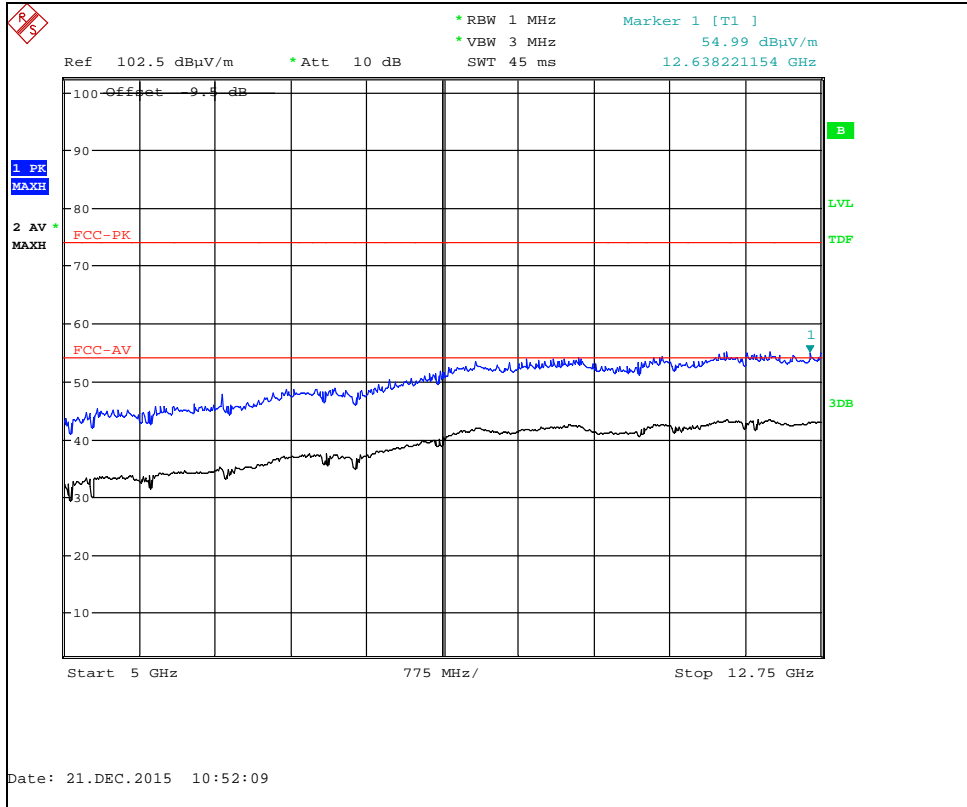

802.11g 54 Mbps Channel 6 : 5 GHz to 12.75 GHz

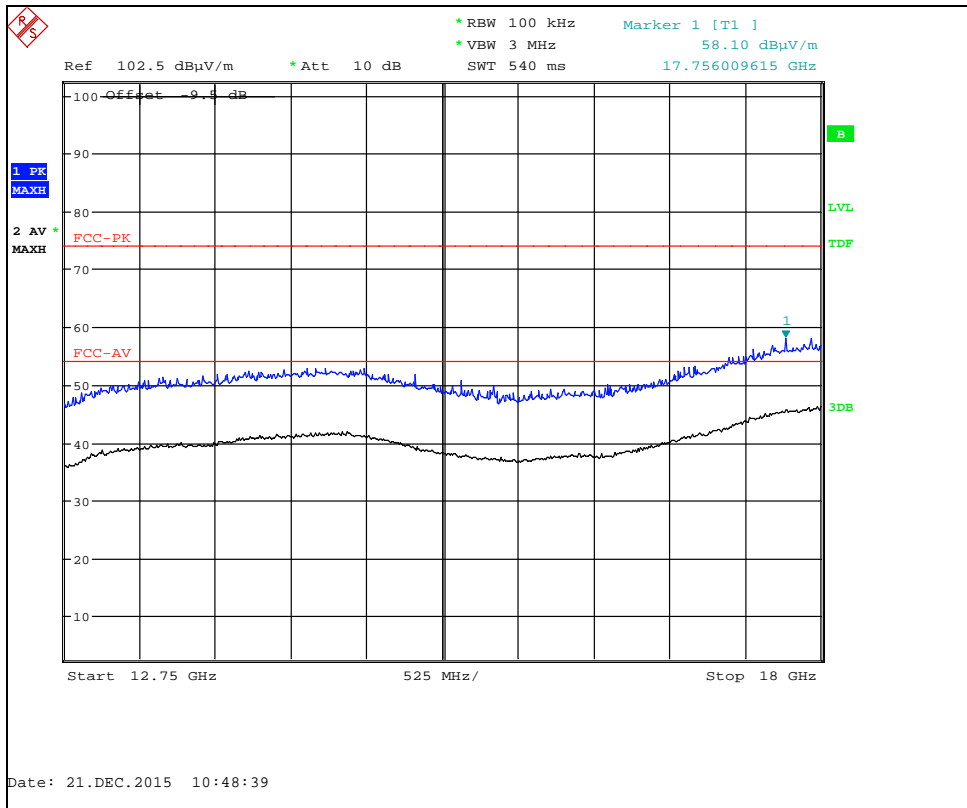

802.11g 54 Mbps Channel 6 : 12.75 GHz to 18 GHz

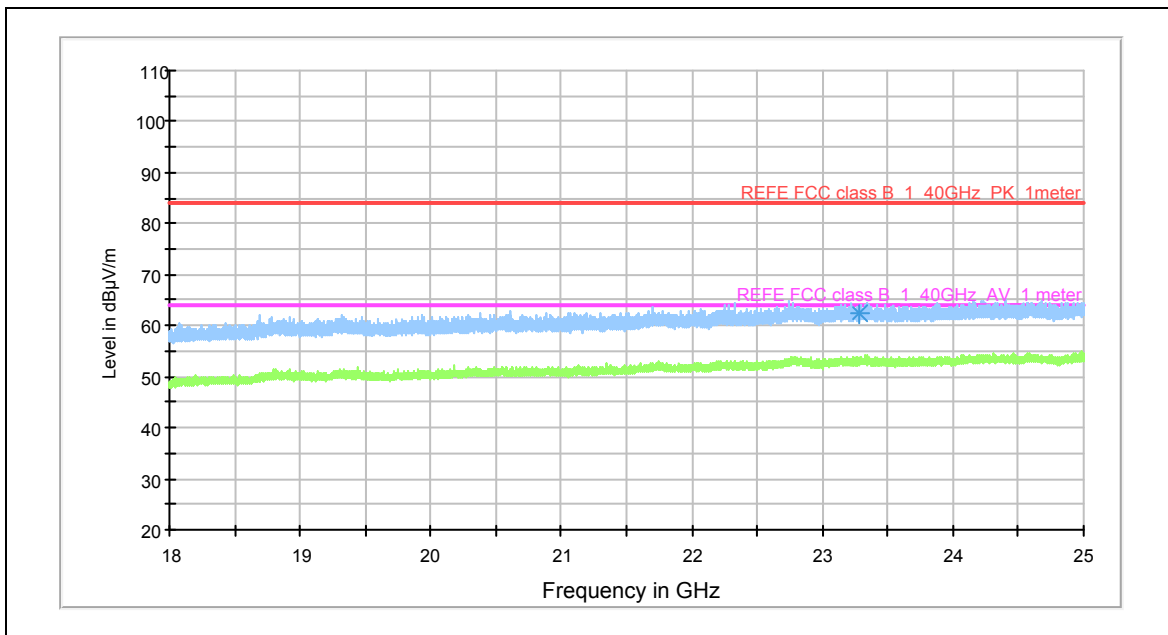

802.11g 54 Mbps Channel 6 : 18 GHz to 25 GHz

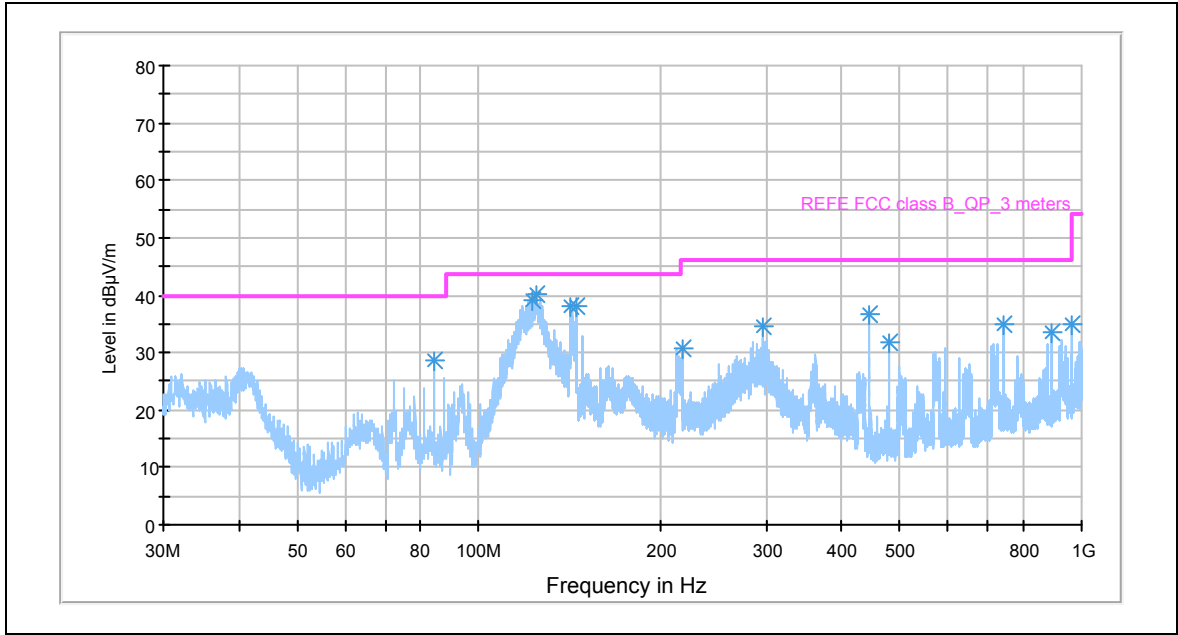

802.11g 54 Mbps Channel 11 : 30 MHz to 1 GHz

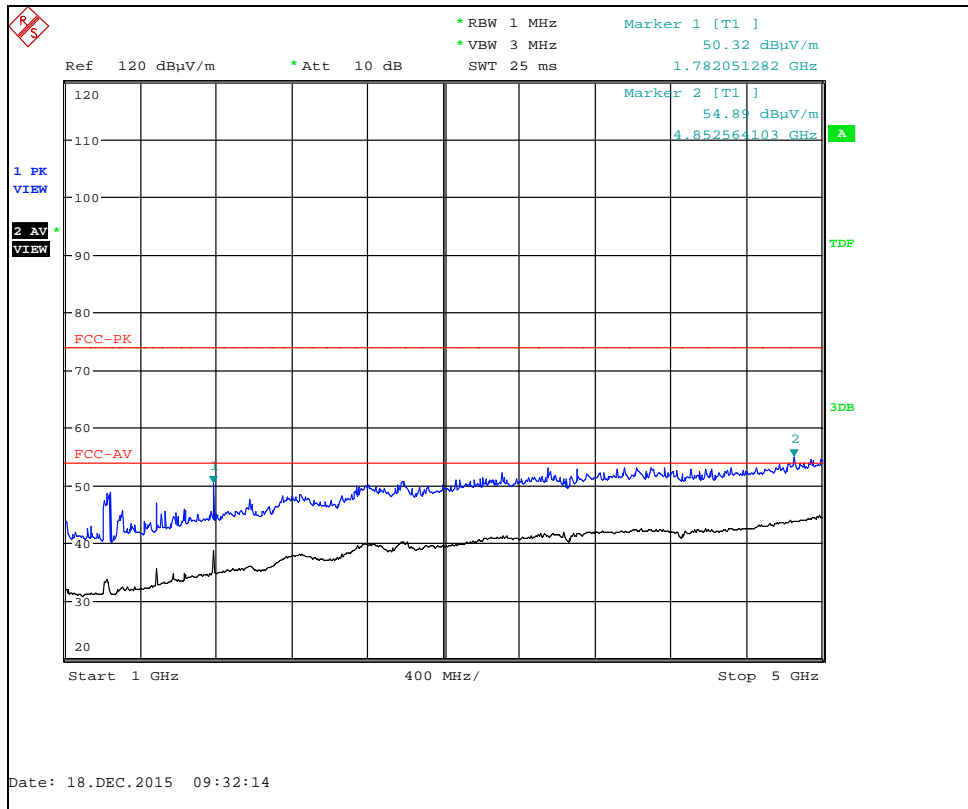

802.11g 54 Mbps Channel 11 : 1 GHz to 5 GHz

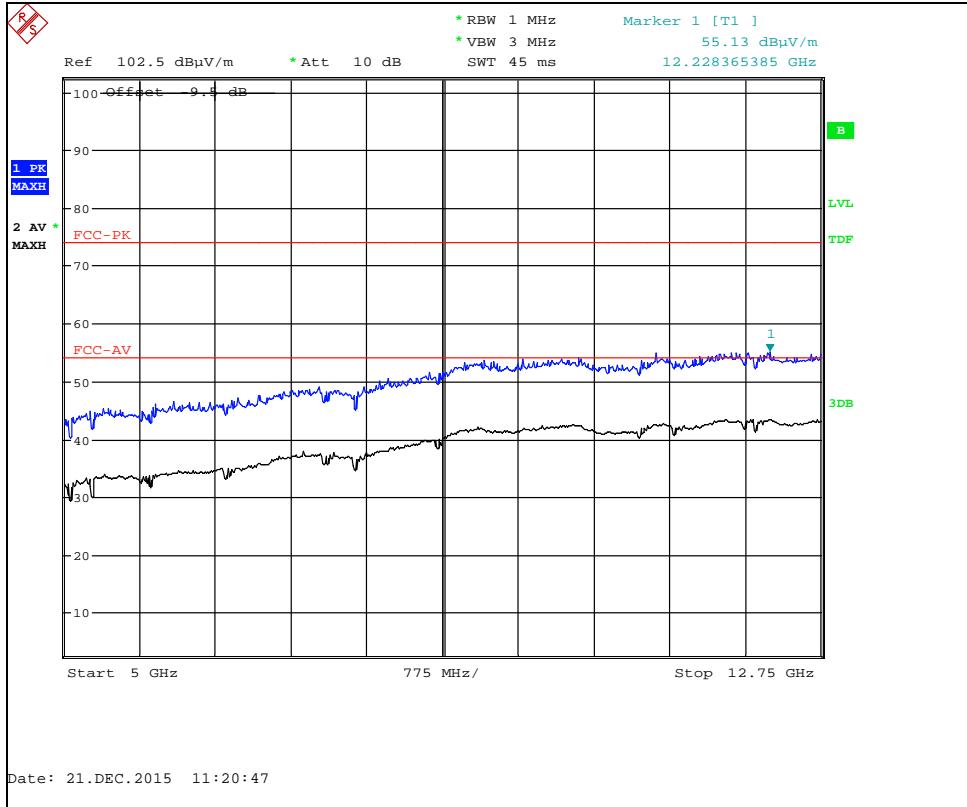

802.11g 54 Mbps Channel 11 : 5 GHz to 12.75 GHz

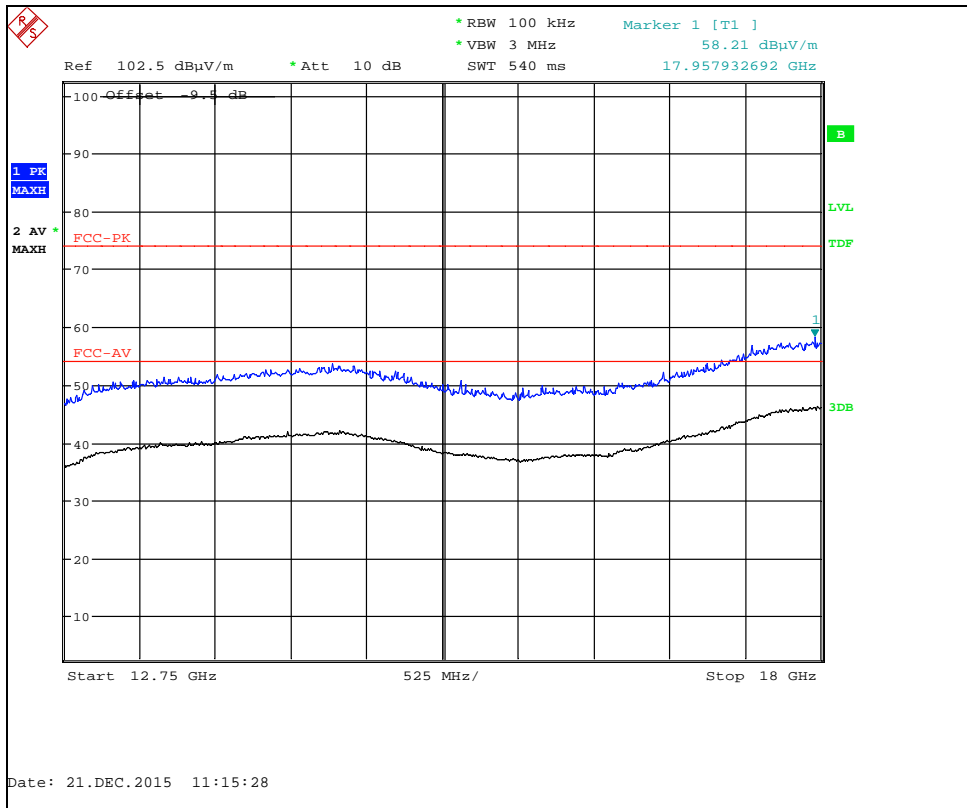

802.11g 54 Mbps Channel 11 : 12.75 GHz to 18 GHz

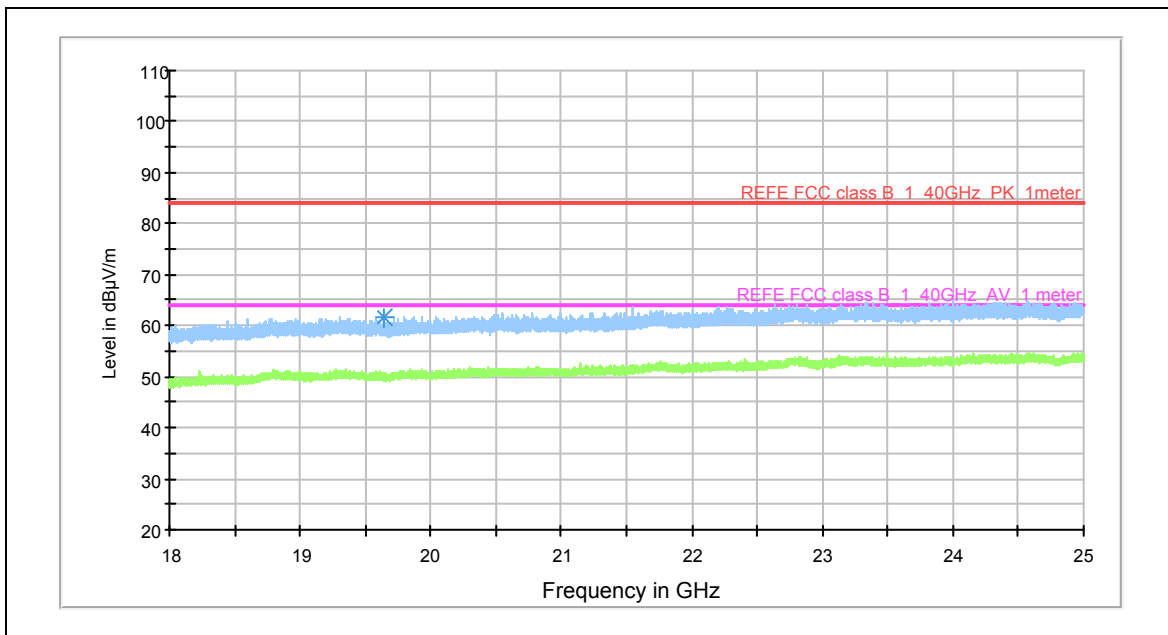

802.11g 54 Mbps Channel 11 : 18 GHz to 25 GHz

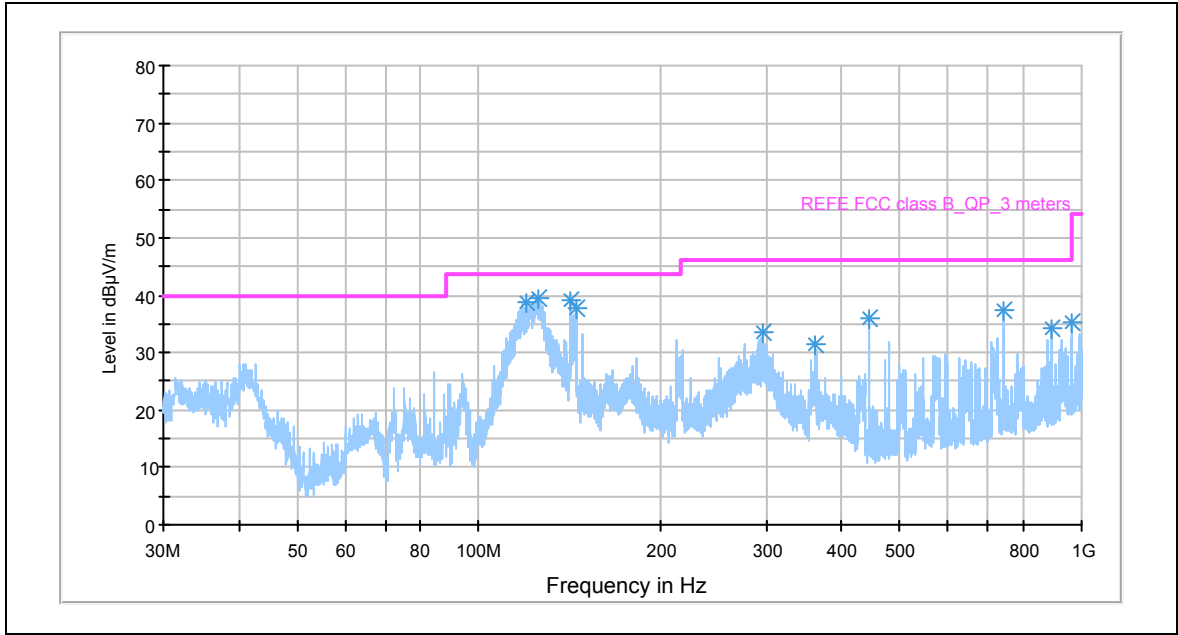

802.11n MCS0 Channel 1 : 30 MHz to 1 GHz

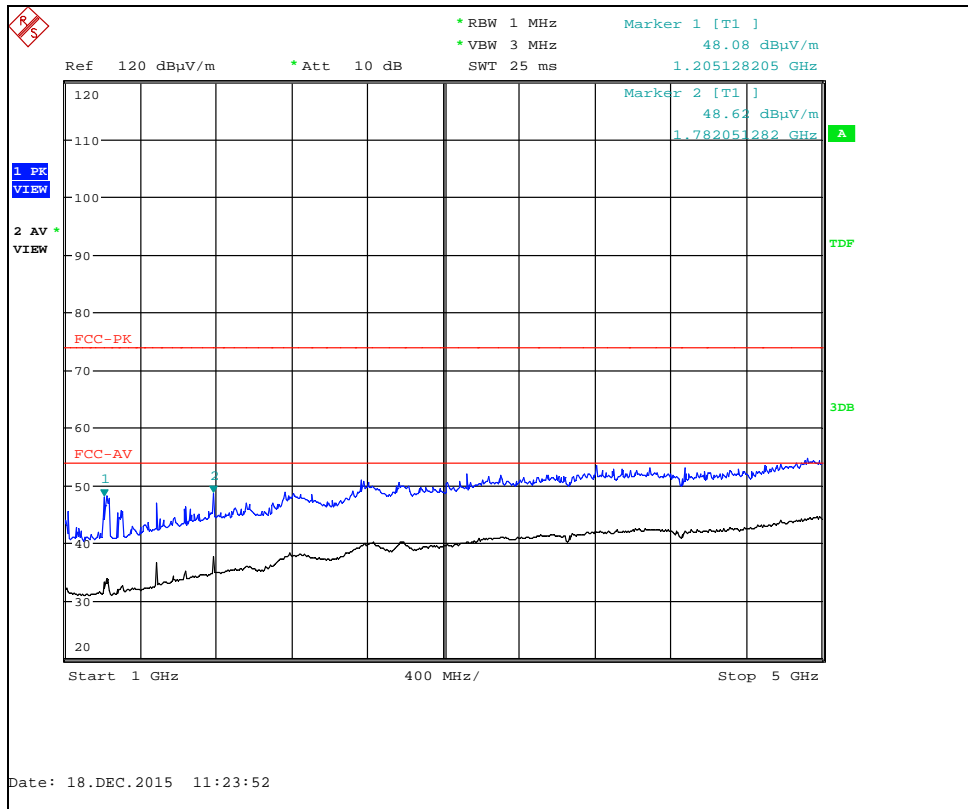

802.11n MCS0 Channel 1 : 1 GHz to 5 GHz

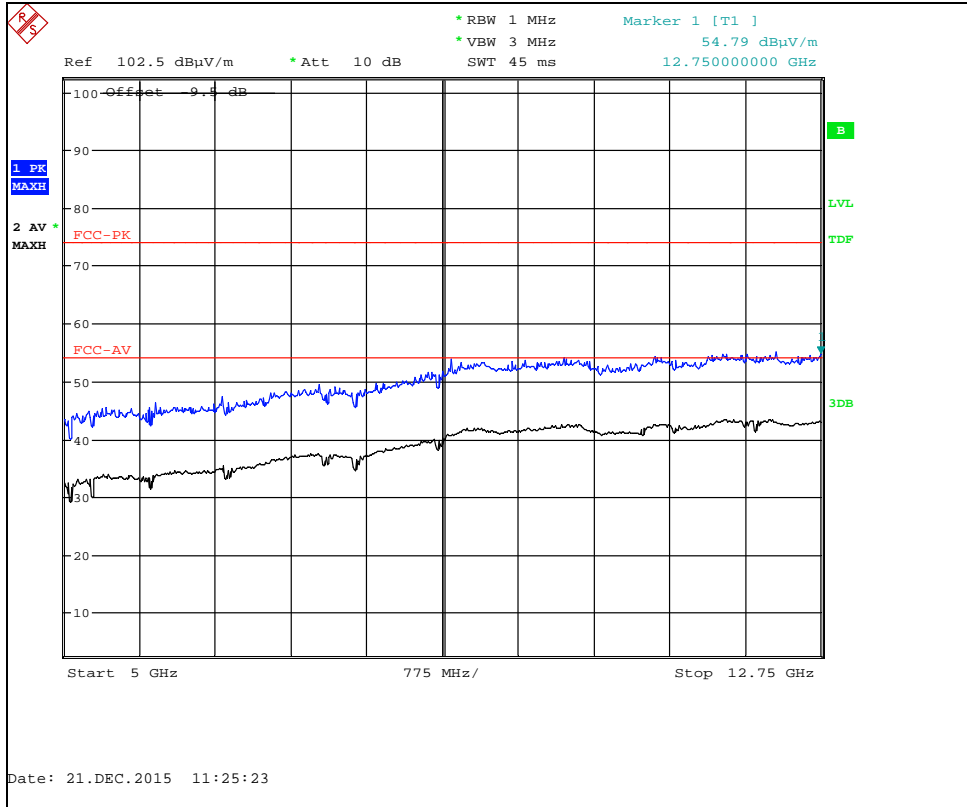

802.11n MCS0 Channel 1 : 5 GHz to 12.75 GHz

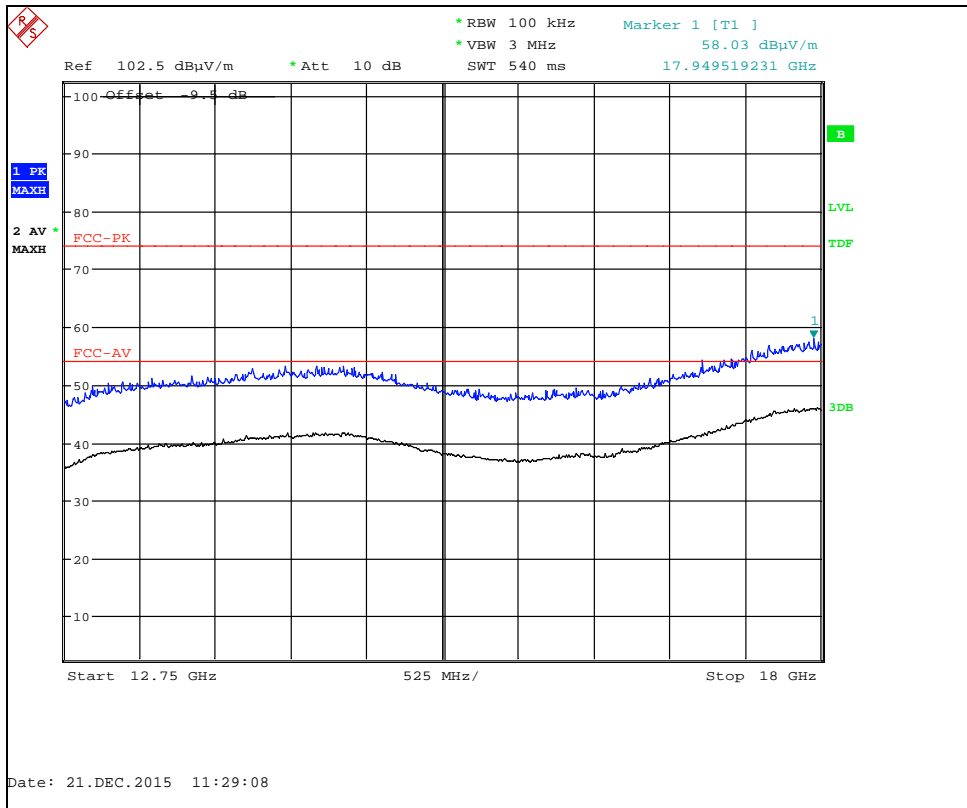

802.11n MCS0 Channel 1 : 12.75 GHz to 18 GHz

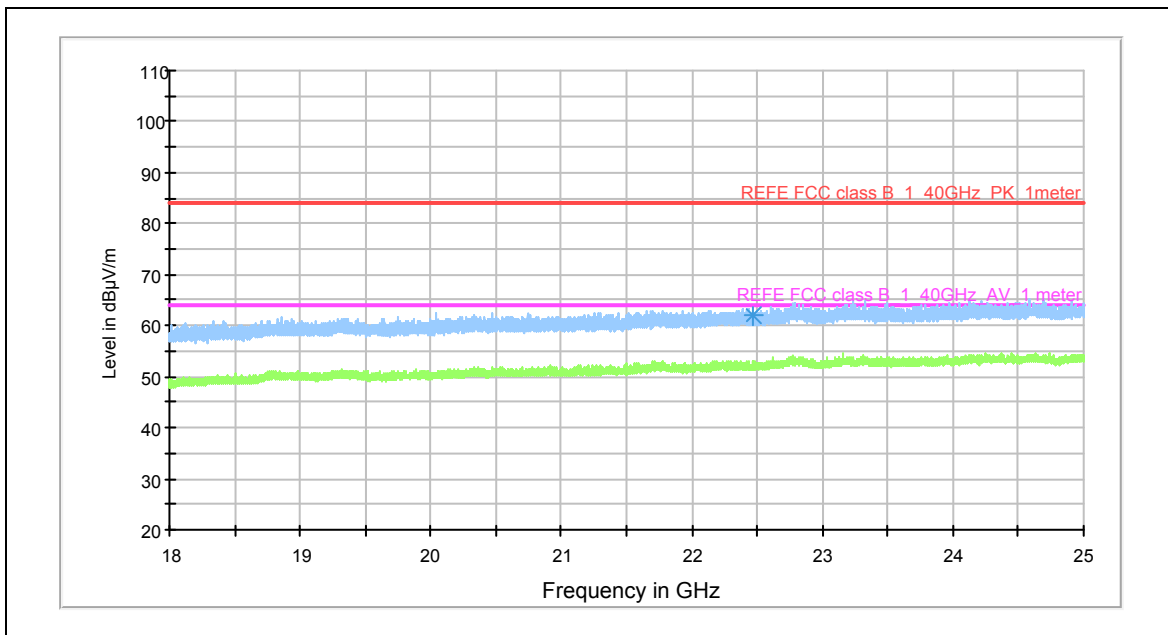

802.11n MCS0 Channel 1 : 18 GHz to 25 GHz

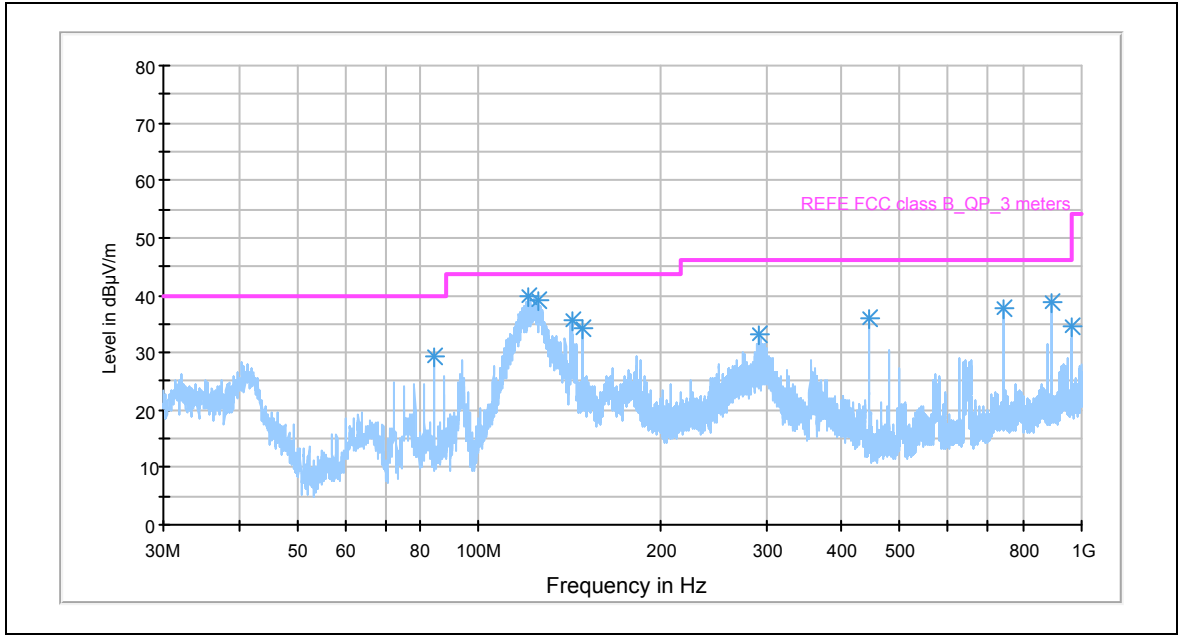

802.11n MCS0 Channel 6 : 30 MHz to 1 GHz

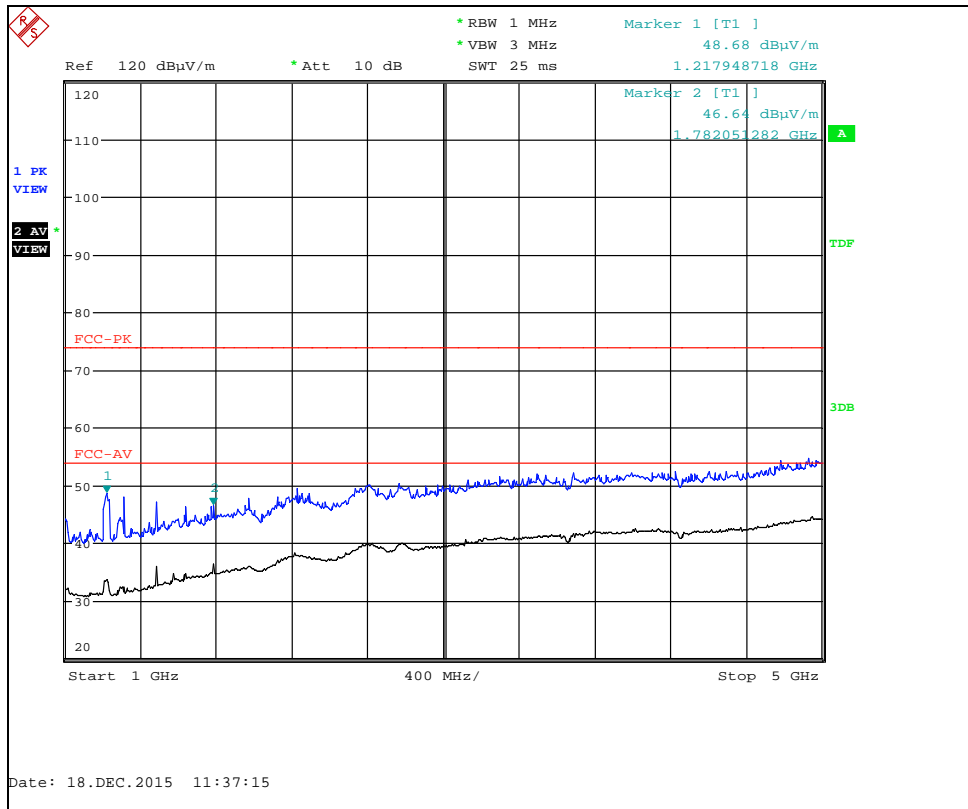

802.11n MCS0 Channel 6 : 1 GHz to 5 GHz

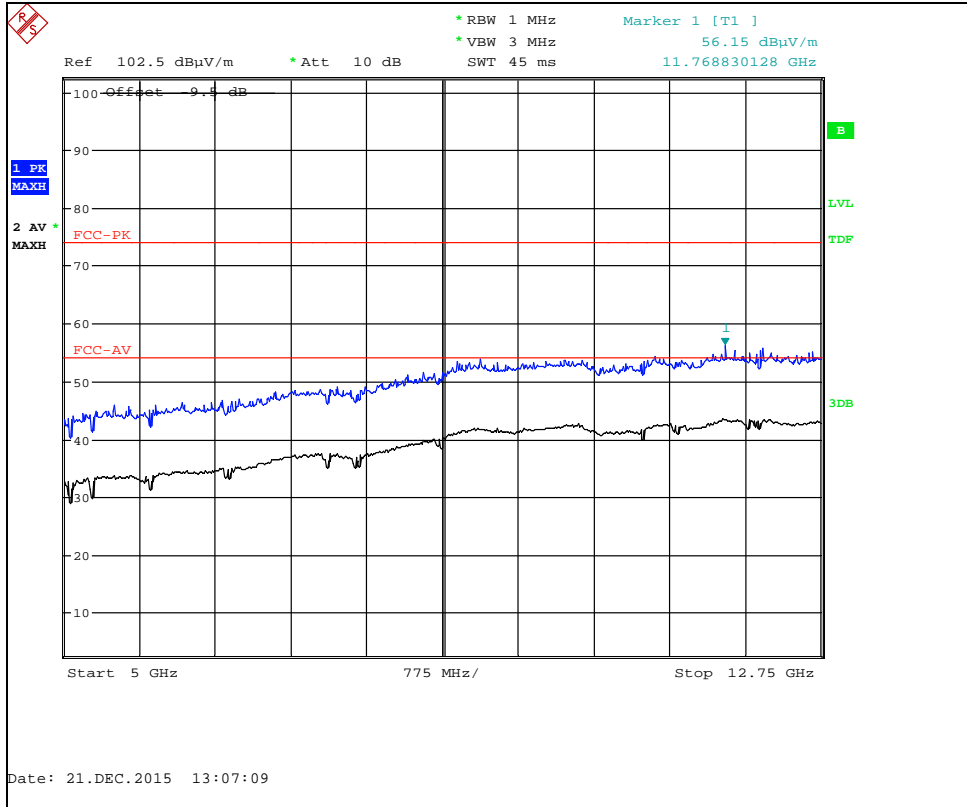

802.11n MCS0 Channel 6 : 5 GHz to 12.75 GHz

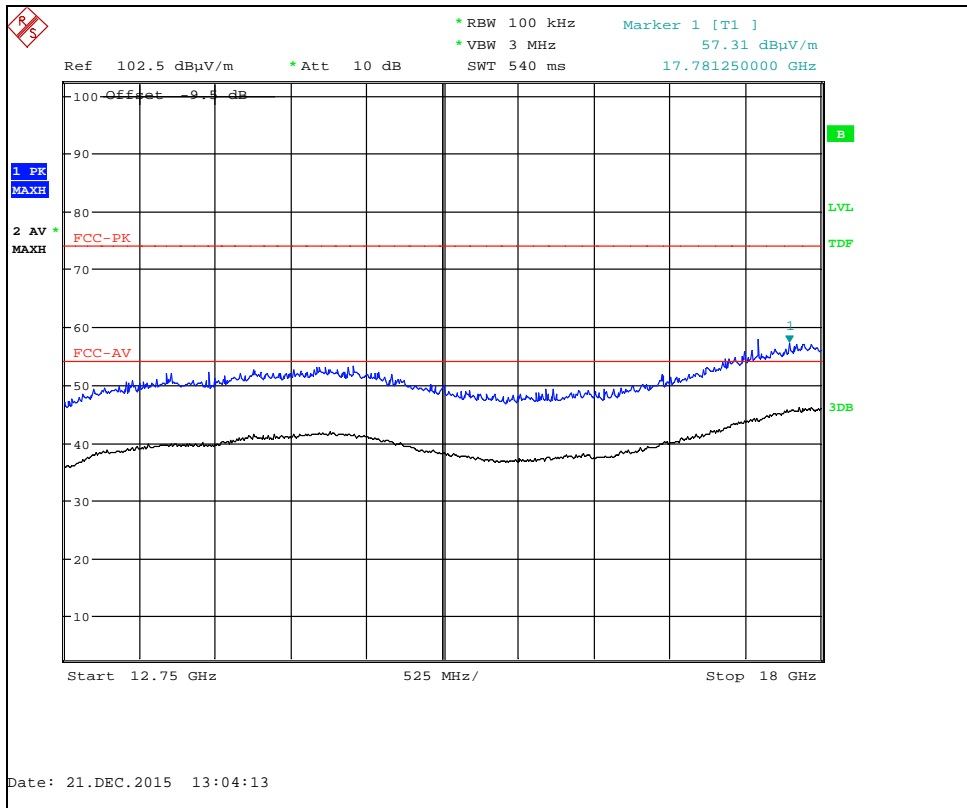

802.11n MCS0 Channel 6 : 12.75 GHz to 18 GHz

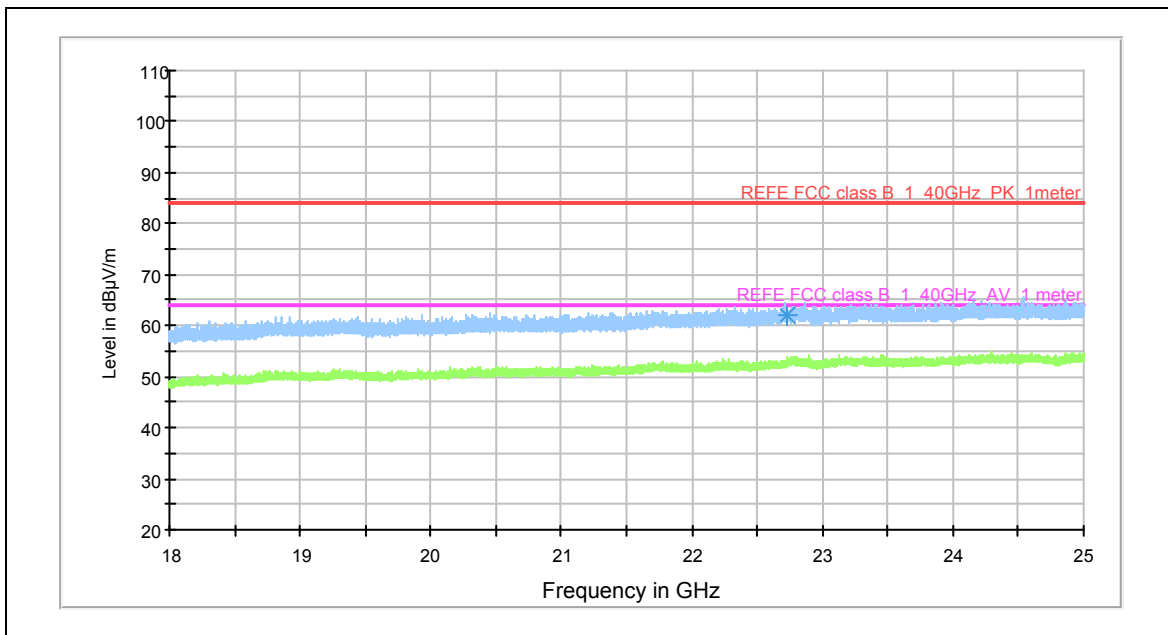

802.11n MCS0 Channel 6 : 18 GHz to 25 GHz

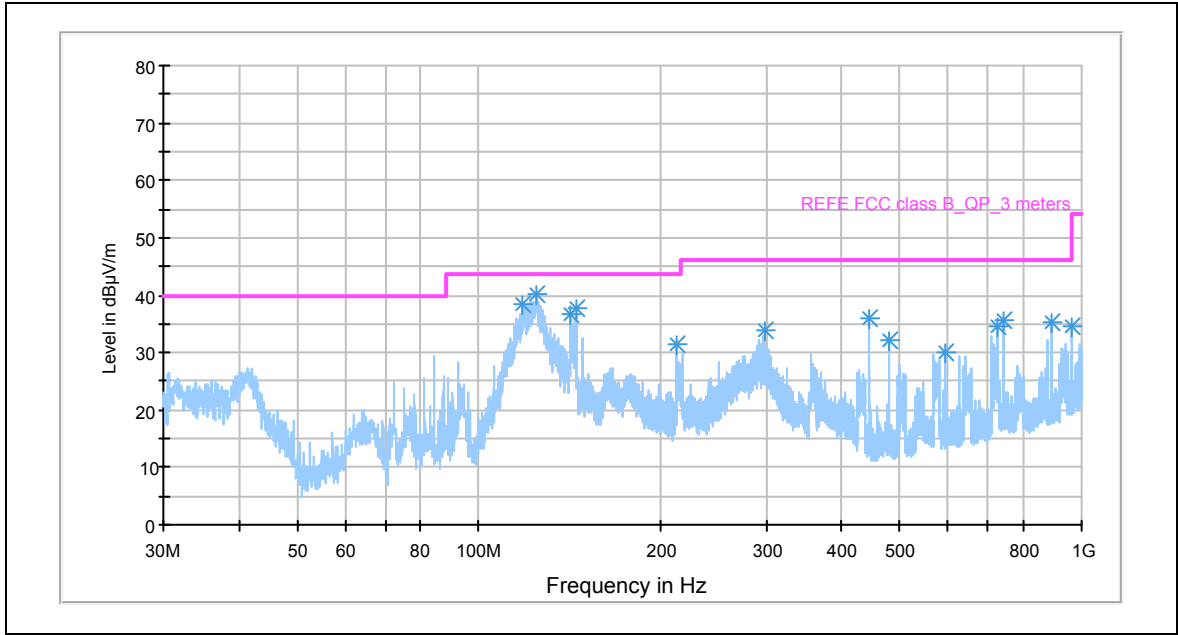

802.11n MCS0 Channel 11 : 30 MHz to 1 GHz

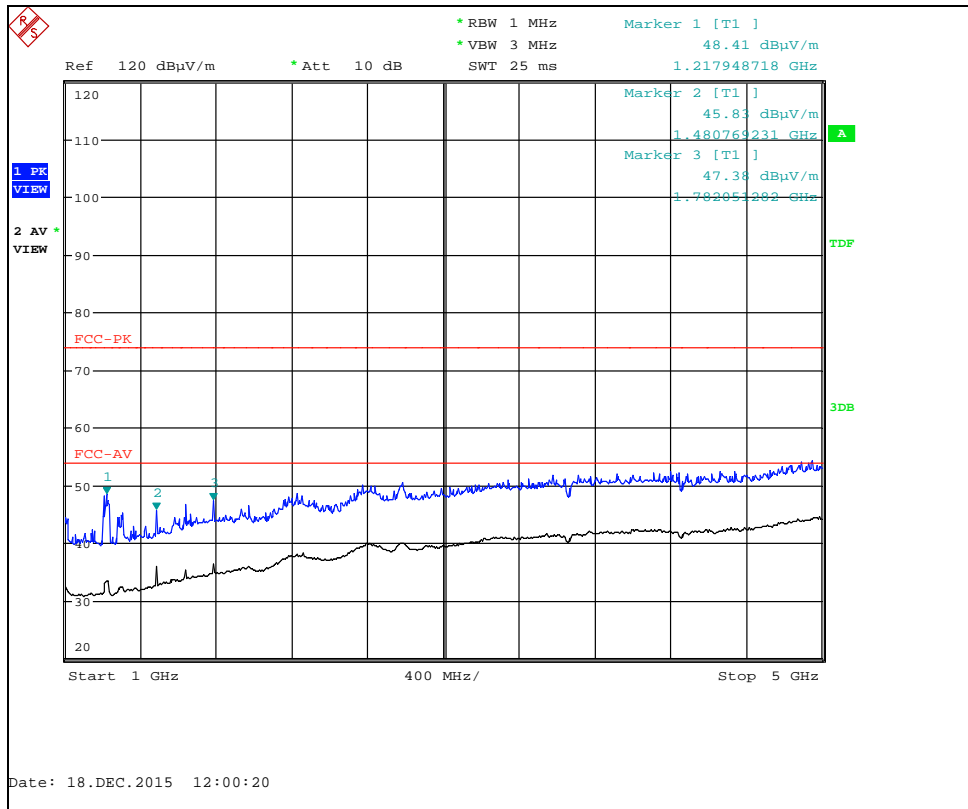

802.11n MCS0 Channel 11 : 1 GHz to 5 GHz

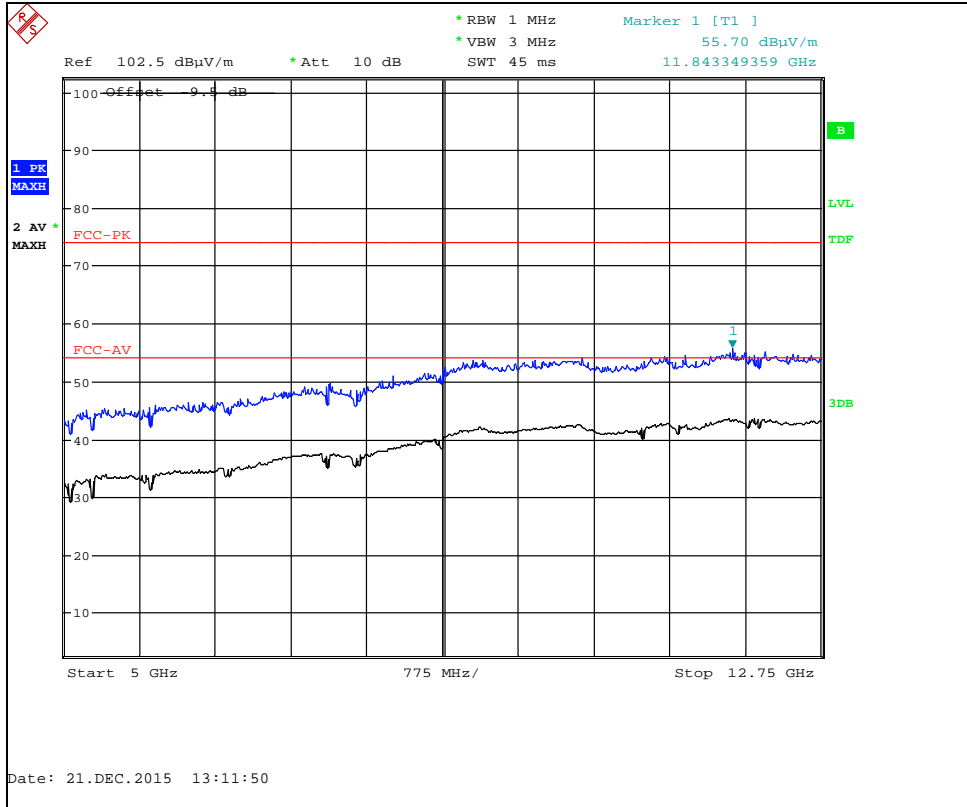

802.11n MCS0 Channel 11 : 5 GHz to 12.75 GHz

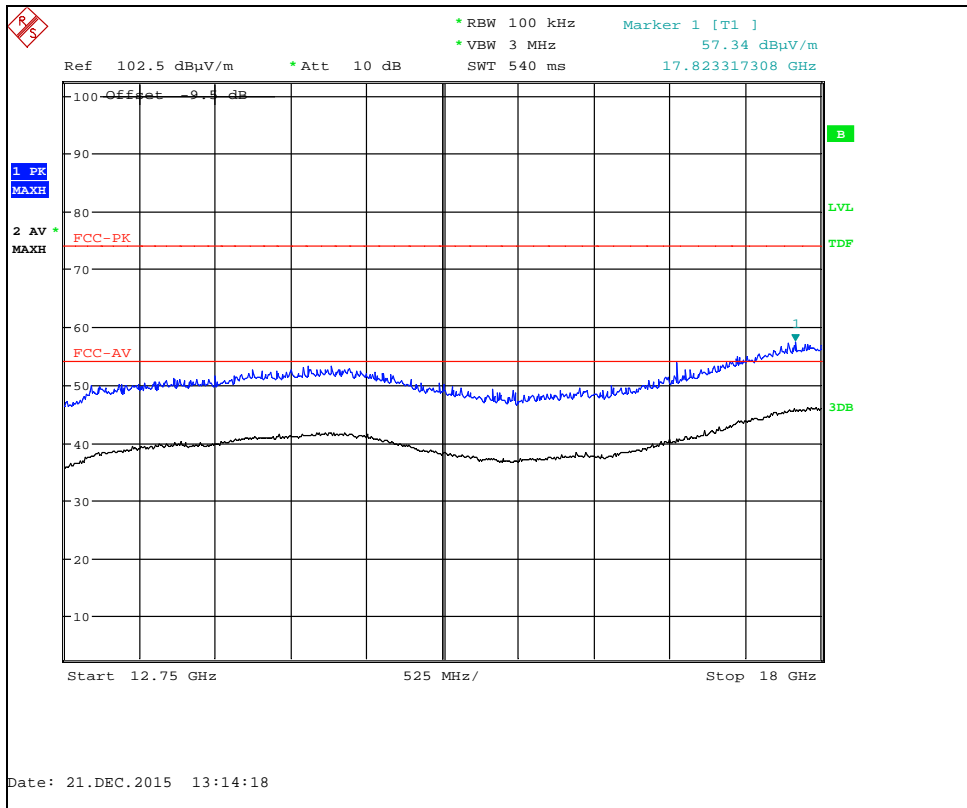

802.11n MCS0 Channel 11 : 12.75 GHz to 18 GHz

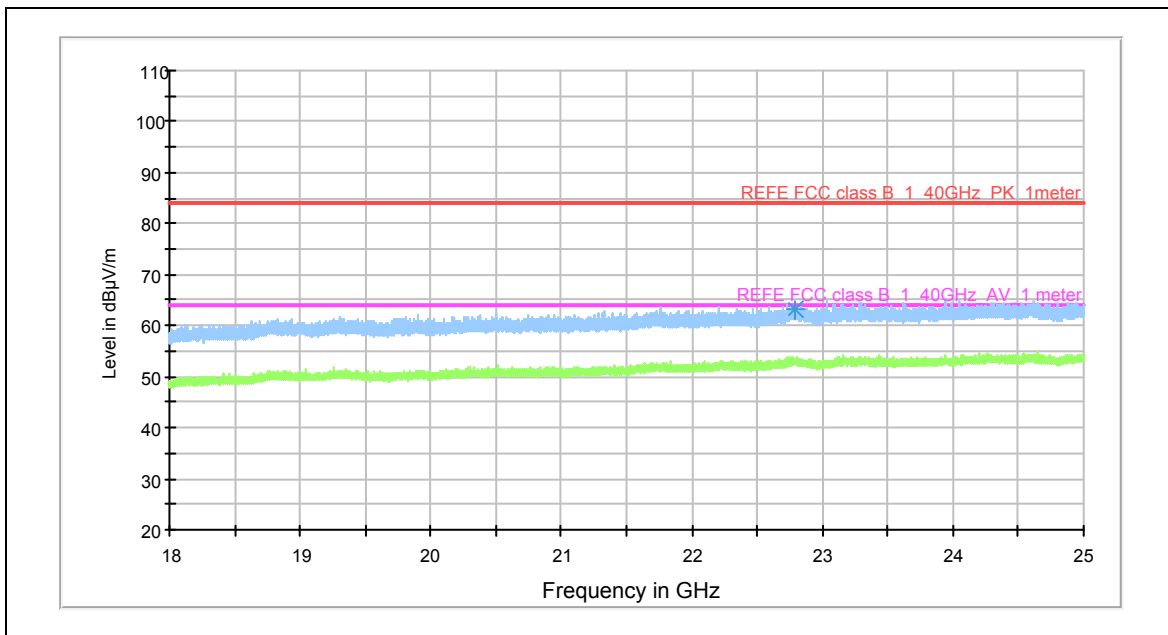

802.11n MCS0 Channel 11 : 18 GHz to 25 GHz

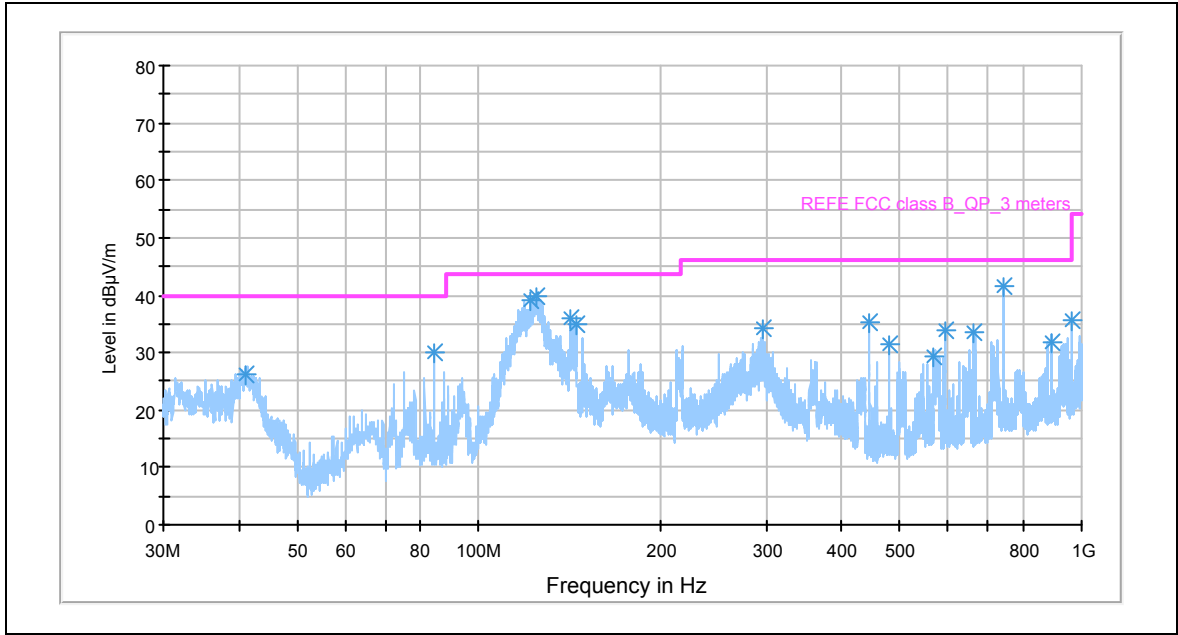

802.11n MCS7 Channel 1 : 30 MHz to 1 GHz

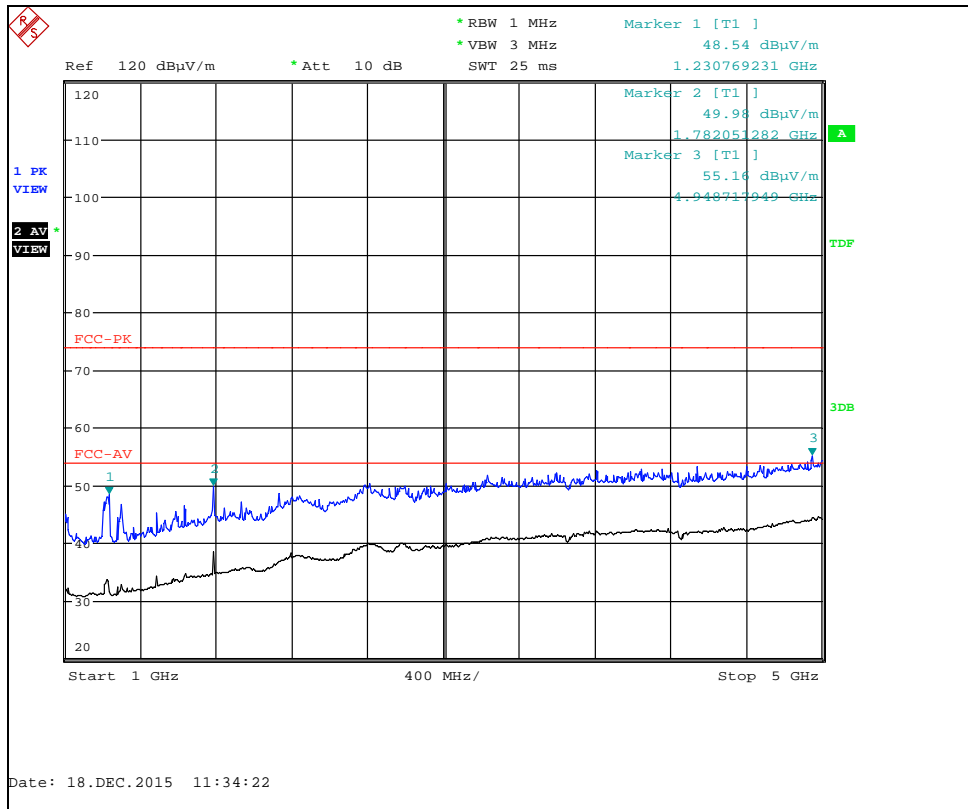

802.11n MCS7 Channel 1 : 1 GHz to 5 GHz

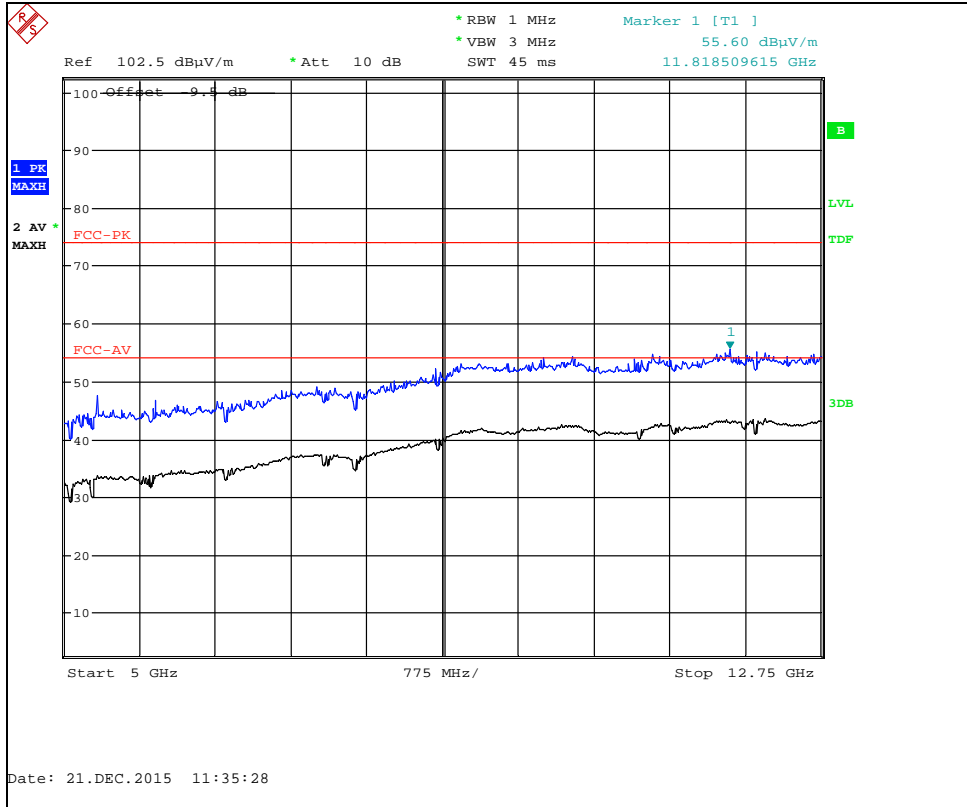

802.11n MCS7 Channel 1 : 5 GHz to 12.75 GHz

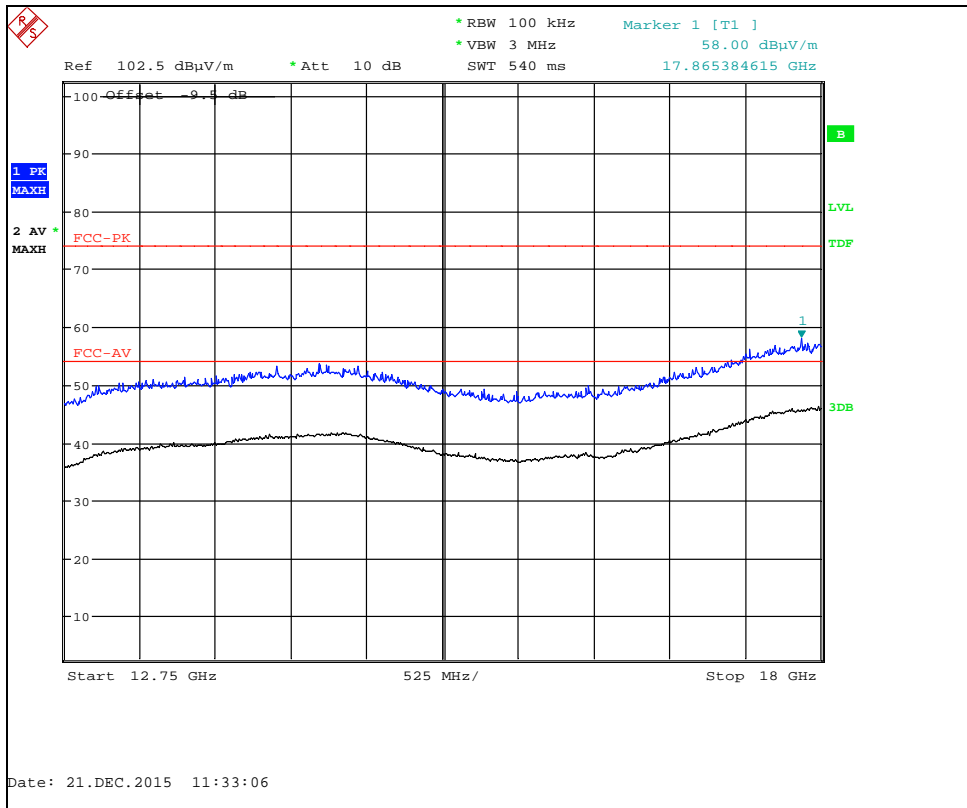

802.11n MCS7 Channel 1 : 12.75 GHz to 18 GHz

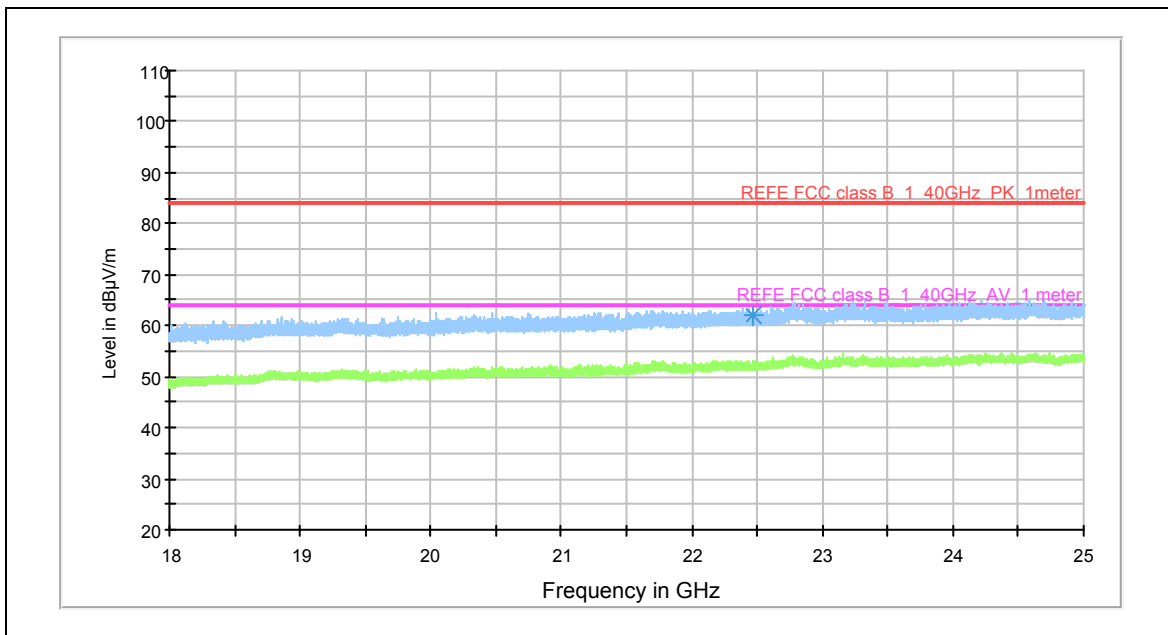

802.11n MCS7 Channel 1 : 18 GHz to 25 GHz

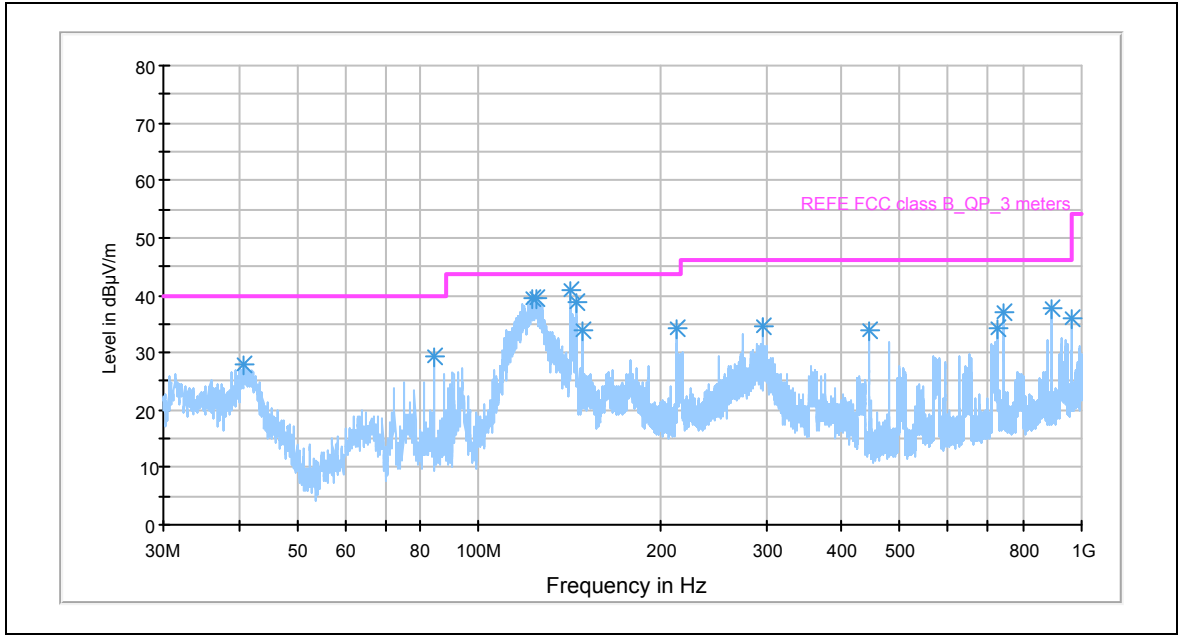

802.11n MCS7 Channel 6 : 30 MHz to 1 GHz

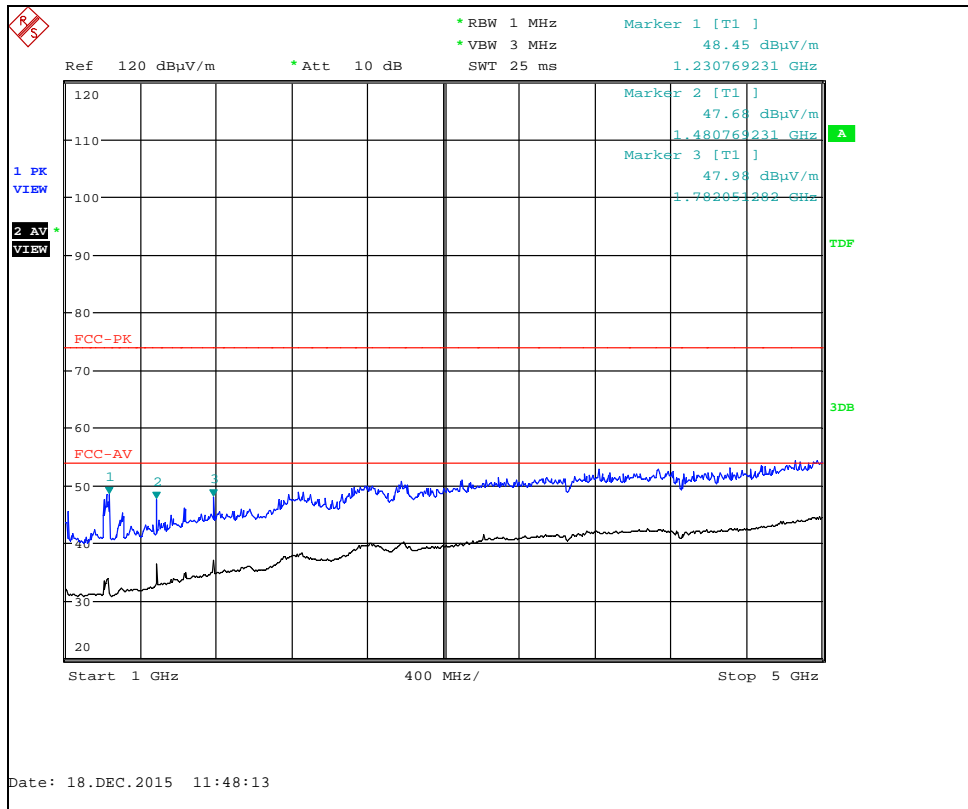

802.11n MCS7 Channel 6 : 1 GHz to 5 GHz

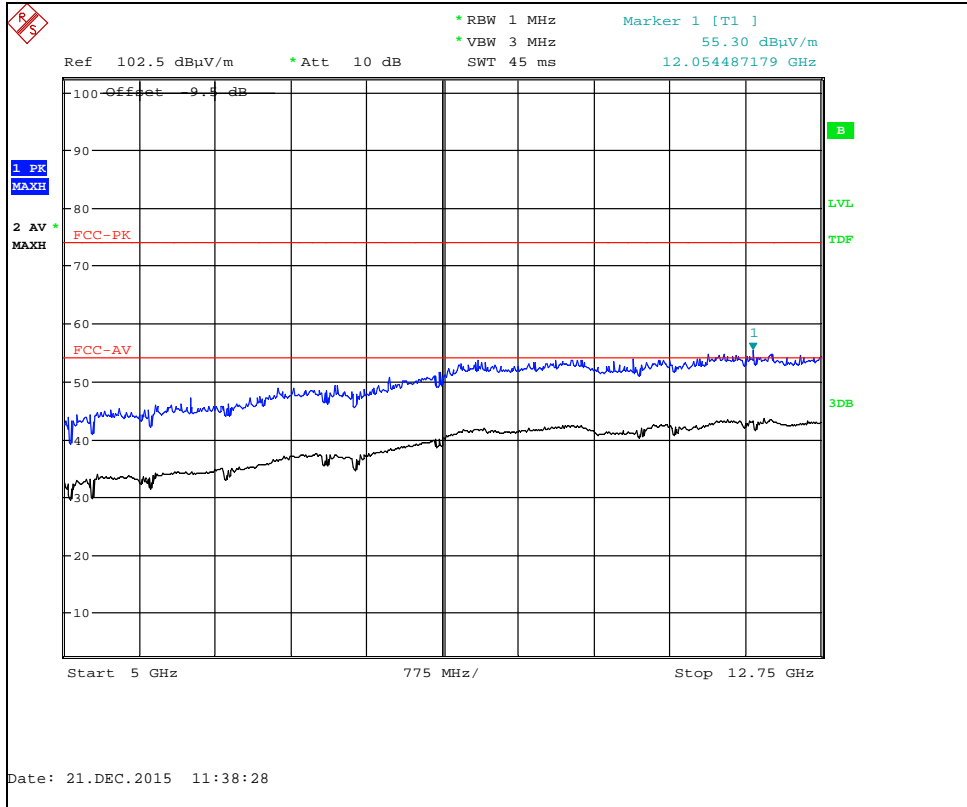

802.11n MCS7 Channel 6 : 5 GHz to 12.75 GHz

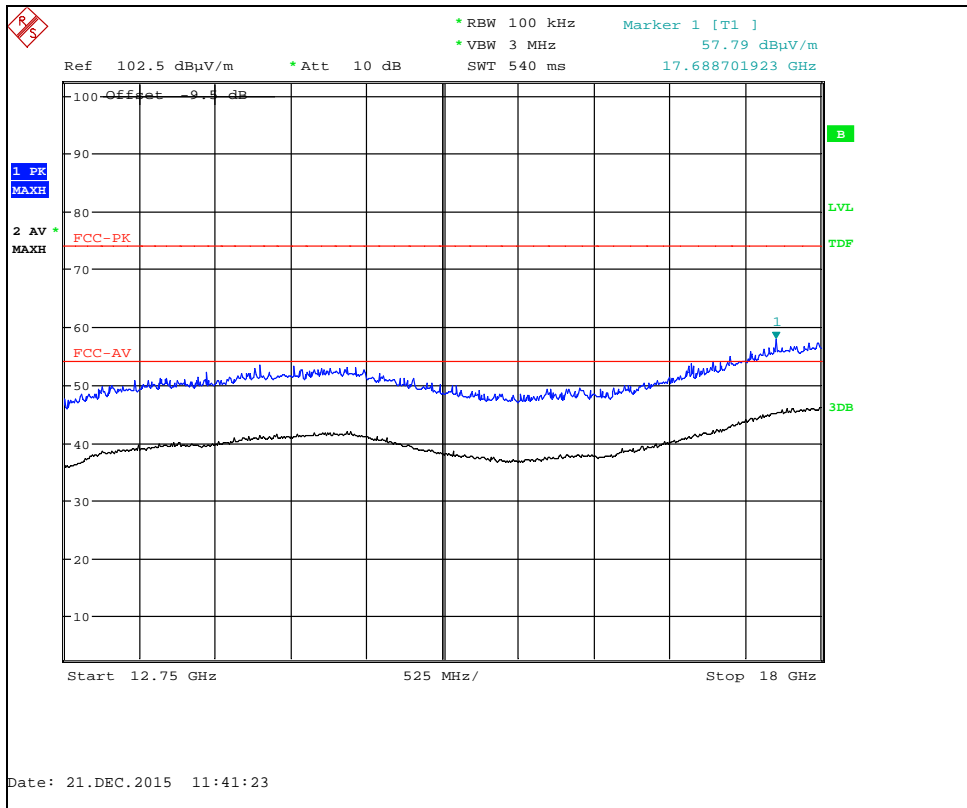

802.11n MCS7 Channel 6 : 12.75 GHz to 18 GHz

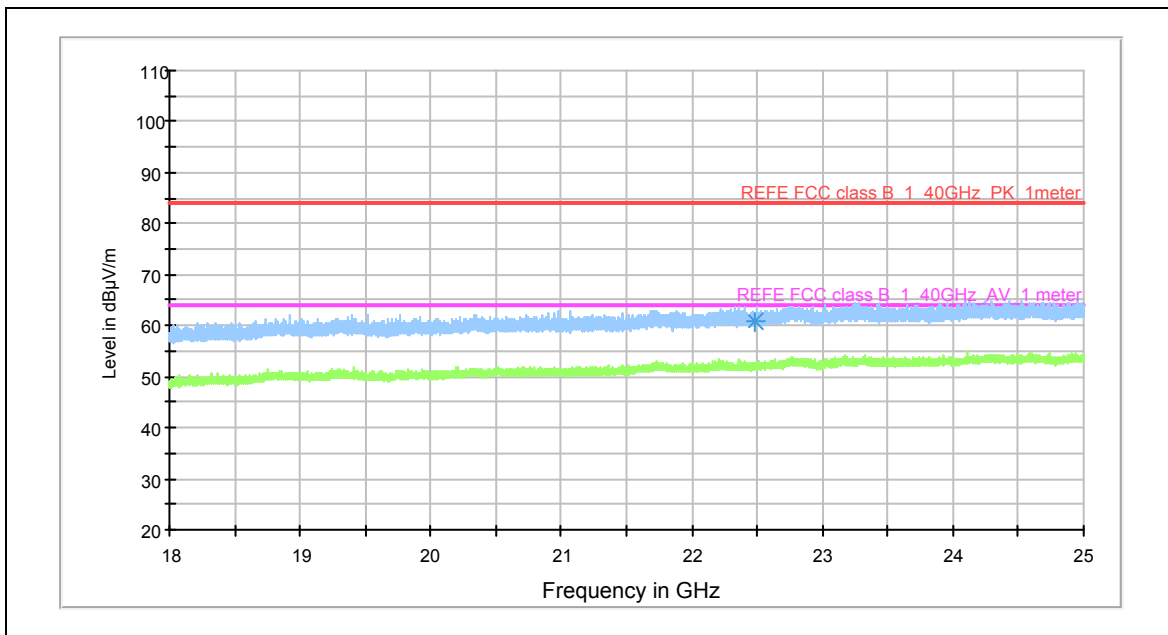

802.11n MCS7 Channel 6 : 18 GHz to 25 GHz

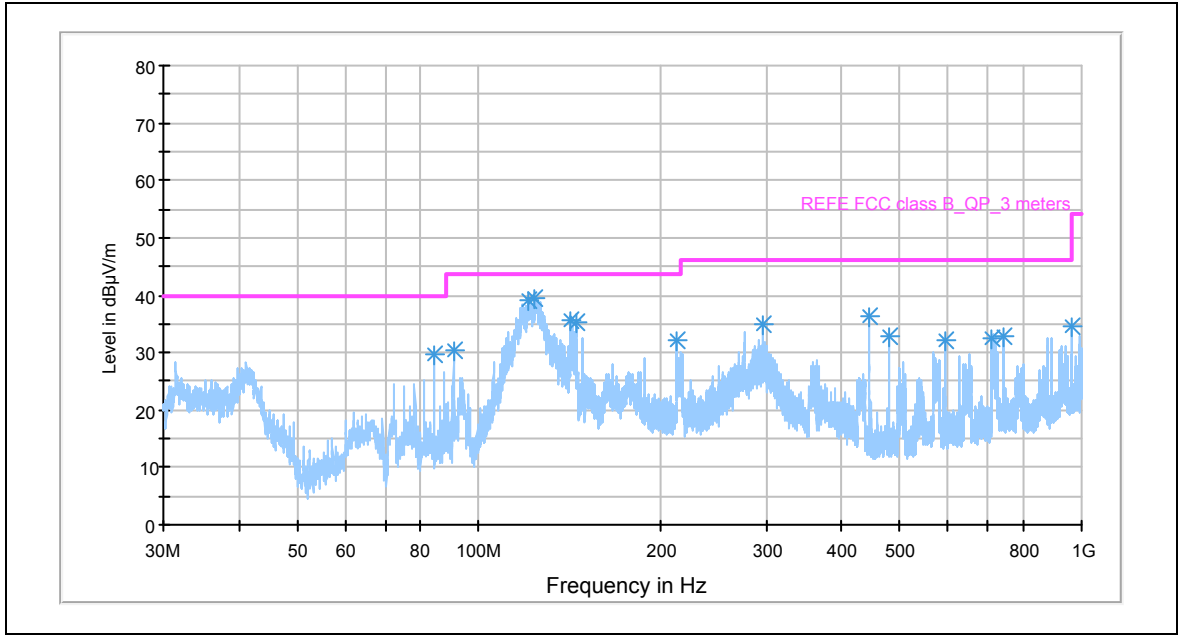

802.11n MCS7 Channel 11 : 30 MHz to 1 GHz

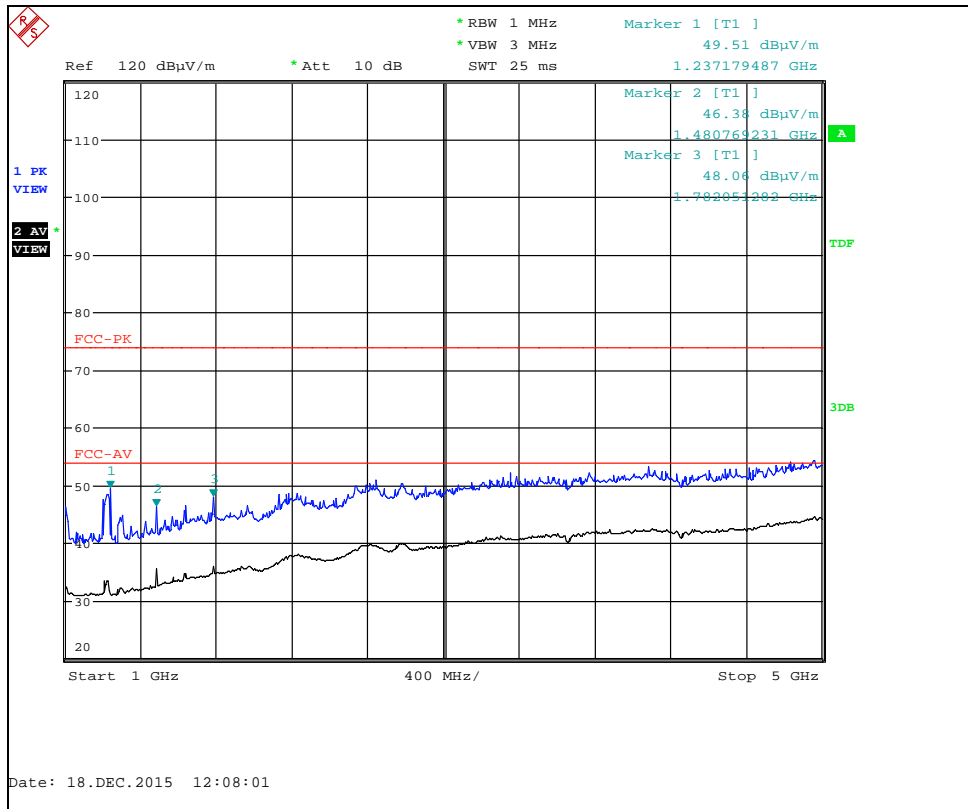

802.11n MCS7 Channel 11 : 1 GHz to 5 GHz

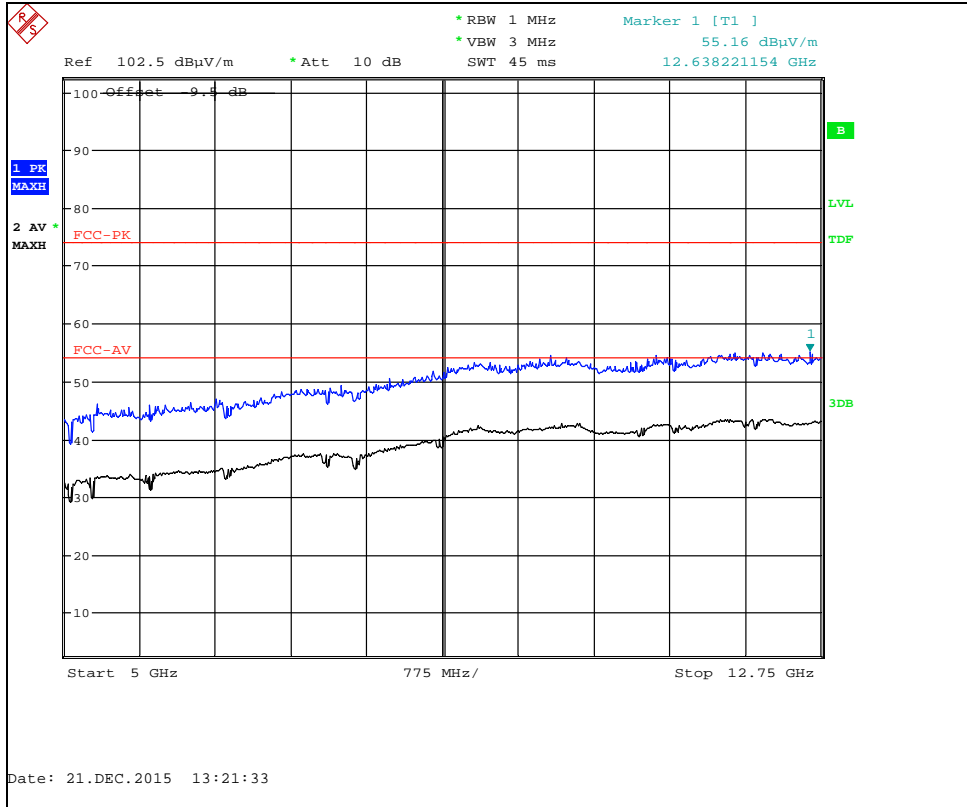

802.11n MCS7 Channel 11 : 5 GHz to 12.75 GHz

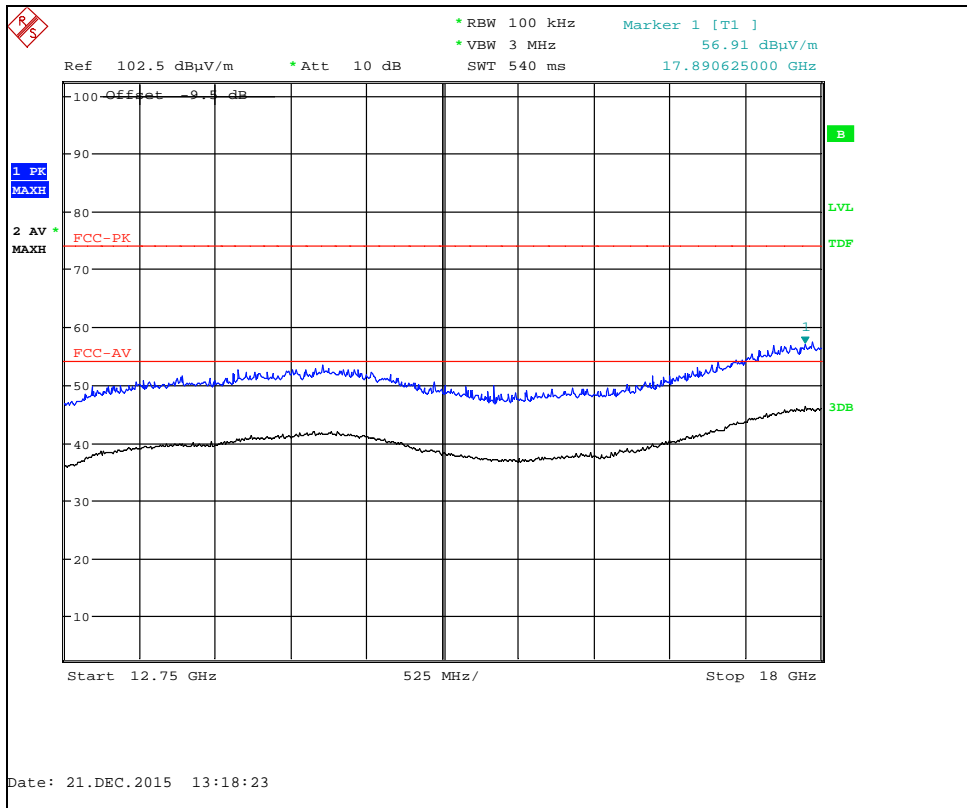

802.11n MCS7 Channel 11 : 12.75 GHz to 18 GHz

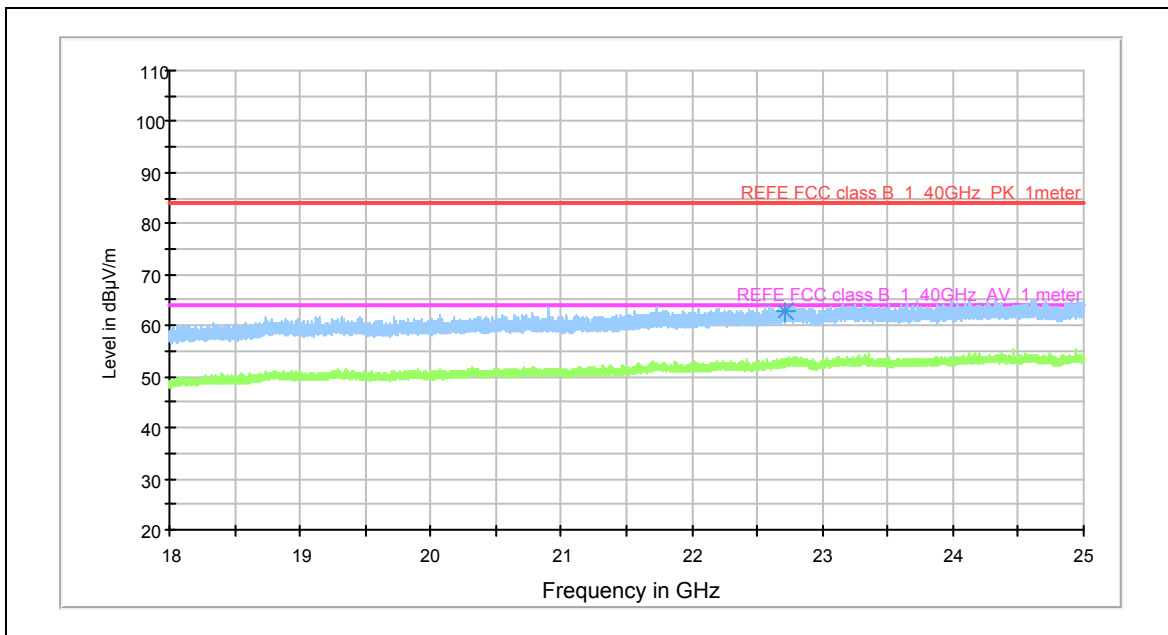

802.11n MCS7 Channel 11 : 18 GHz to 25 GHz

Frequency (MHz)	QuasiPeak (dBµV/m)	Meas. Time (ms)	Bandwidth (kHz)	Height (cm)	Polarization	Azimuth (deg)	Corr. (dB)	Margin (dB)	Limit (dBµV/m)
41.454267	23.6	15000.0	120.000	105.0	V	276.0	-18.0	16.4	40.0
72.337707	29.6	15000.0	120.000	234.0	H	152.0	-23.8	10.4	40.0
84.406267	28.7	15000.0	120.000	131.0	V	248.0	-22.0	11.3	40.0
90.776413	26.4	15000.0	120.000	209.0	H	160.0	-21.2	17.1	43.5
117.406427	32.3	15000.0	120.000	101.0	V	105.0	-18.5	11.2	43.5
124.151080	33.4	15000.0	120.000	101.0	V	116.0	-18.4	10.1	43.5
142.039800	28.4	15000.0	120.000	101.0	V	41.0	-18.3	15.1	43.5
144.674667	29.8	15000.0	120.000	140.0	V	37.0	-18.6	13.7	43.5
148.500707	34.2	15000.0	120.000	101.0	V	39.0	-18.8	9.3	43.5
290.670240	25.7	15000.0	120.000	209.0	V	27.0	-16.9	20.3	46.0
445.509667	38.9	15000.0	120.000	101.0	H	157.0	-13.0	7.1	46.0
480.008853	34.5	15000.0	120.000	223.0	H	215.0	-12.1	11.5	46.0
567.312907	23.3	15000.0	120.000	208.0	H	63.0	-9.6	22.7	46.0
742.505907	42.2	15000.0	120.000	123.0	H	92.0	-6.9	3.8	46.0
891.001693	35.5	15000.0	120.000	163.0	H	162.0	-5.7	10.5	46.0
960.012853	36.6	15000.0	120.000	101.0	H	150.0	-3.3	17.4	54.0

High Power; Channel: 2412 MHz; 802.11b 1Mbps

Detector	Freq. (MHz)	Meas'd Emission (dBµV)	Cable Loss (dB)	Antenna Factor (dB/m)	Pre-amp Gain (dB)	Duty Cycle Corr'n (dB)	Distance Extrap'n Factor (dB)	Field Strength (dBµV/m)	Field Strength (µV/m)	Limit (µV/m)
Pk	2400.000	58.28	7.3	28.4	33.76	0	0	59.4	933.25	19498
Av	2400.000	51	7.3	28.4	33.75	0	0	52.1	402.72	19498
Pk	2389.038	53.5	7.3	28.4	33.75	0	0	54.5	530.88	5000
Av	2389.038	43.78	7.2	28.4	33.75	0	0	44.8	173.78	500

High Power; Channel: 2412 MHz; 802.11b 11Mbps

Detector	Freq. (MHz)	Meas'd Emission (dBµV)	Cable Loss (dB)	Antenna Factor (dB/m)	Pre-amp Gain (dB)	Duty Cycle Corr'n (dB)	Distance Extrap'n Factor (dB)	Field Strength (dBµV/m)	Field Strength (µV/m)	Limit (µV/m)
Pk	1000.000	43.5	3.7	25.3	34.58	0	0	36.9	69.98	5000
Av	1000.000	32.1	3.7	25.3	34.58	0	0	25.5	18.84	500
Pk	1230.753	47.6	3.8	25.5	34.2	0	0	41.7	121.62	5000
Av	1230.753	31.3	3.8	25.5	34.2	0	0	25.4	18.62	500
Pk	2227.438	54	6.4	27.9	33.71	0	0	53.7	484.17	5000
Av	2227.438	35.1	6.4	27.9	33.71	0	0	34.8	54.95	500
Pk	2400.000	56	7.3	28.4	33.75	0	0	57.1	716.14	18836
Av	2400.000	46.86	7.3	28.4	33.75	0	0	47.9	248.31	18836
Pk	2390.000	52.6	7.1	28.4	33.75	0	0	53.5	473.15	5000
Av	2390.000	42	7.1	28.4	33.75	0	0	42.9	139.64	500
Pk	4823.717	41	9.1	33	34.04	0	0	48.4	263.03	5000
Av	4823.717	30.1	9.1	33	34.04	0	0	37.5	74.99	500

High Power; Channel: 2412 MHz; 802.11g 6Mbps										
Detector	Freq. (MHz)	Meas'd Emission (dBµV)	Cable Loss (dB)	Antenna Factor (dB/m)	Pre-amp Gain (dB)	Duty Cycle Corr'n (dB)	Distance Extrap'n Factor (dB)	Field Strength (dBµV/m)	Field Strength (µV/m)	Limit (µV/m)
Pk	2400.000	64.3	7.3	28.4	33.75	0	0	65.4	1862.09	10471
Av	2400.000	53.12	7.3	28.4	33.75	0	0	54.2	512.86	10471
Pk	2390.000	59.2	7.1	28.4	33.75	0	0	60.1	1011.58	5000
Av	2390.000	43.5	7.1	28.4	33.75	0	0	44.4	165.96	500

High Power; Channel: 2412 MHz; 802.11g 54Mbps										
Detector	Freq. (MHz)	Meas'd Emission (dBµV)	Cable Loss (dB)	Antenna Factor (dB/m)	Pre-amp Gain (dB)	Duty Cycle Corr'n (dB)	Distance Extrap'n Factor (dB)	Field Strength (dBµV/m)	Field Strength (µV/m)	Limit (µV/m)
Pk	2400.000	63.05	7.3	28.4	33.75	0	0	64.1	1603.25	12162
Av	2400.000	52.91	7.3	28.4	33.75	0	0	54.0	501.19	12162
Pk	2390.000	69.8	7.1	28.4	33.75	0	0	70.7	3427.68	5000
Av	2390.000	43.91	7.1	28.4	33.75	0	0	44.8	173.78	500
Pk	2387.627	66.73	7.2	28.4	33.75	0	0	67.7	2426.61	5000
Av	2387.627	42	7.2	28.4	33.75	0	0	43.0	141.25	500

High Power; Channel: 2412 MHz; 802.11n MCS0										
Detector	Freq. (MHz)	Meas'd Emission (dBµV)	Cable Loss (dB)	Antenna Factor (dB/m)	Pre-amp Gain (dB)	Duty Cycle Corr'n (dB)	Distance Extrap'n Factor (dB)	Field Strength (dBµV/m)	Field Strength (µV/m)	Limit (µV/m)
Pk	2400.000	64.31	7.3	28.4	33.75	0	0	65.4	1862.09	11350
Av	2400.000	54.38	7.3	28.4	33.75	0	0	55.5	595.66	11350
Pk	2390.000	64.91	7.1	28.4	33.75	0	0	65.8	1949.84	5000
Av	2390.000	45	7.1	28.4	33.75	0	0	45.9	197.24	500
Pk	2327.500	54.87	6.9	28.2	33.74	0	0	55.4	588.84	5000
Av	2327.500	37.06	6.9	28.2	33.74	0	0	37.6	75.86	500

High Power; Channel: 2412 MHz; 802.11n MCS7										
Detector	Freq. (MHz)	Meas'd Emission (dBµV)	Cable Loss (dB)	Antenna Factor (dB/m)	Pre-amp Gain (dB)	Duty Cycle Corr'n (dB)	Distance Extrap'n Factor (dB)	Field Strength (dBµV/m)	Field Strength (µV/m)	Limit (µV/m)
Pk	2400.000	64.88	7.3	28.4	33.75	0	0	66	1995.26	12589
Av	2400.000	52.94	7.3	28.4	33.75	0	0	54.0	501.19	12589
Pk	2388.269	68.57	7.2	28.4	33.75	0	0	69.6	3019.95	5000
Av	2388.269	42.1	7.2	28.4	33.75	0	0	43.1	142.89	500
Pk	2384.038	66.46	7.1	28.4	33.75	0	0	67.3	2317.39	5000
Av	2384.038	40.1	7.1	28.4	33.75	0	0	41.0	112.20	500

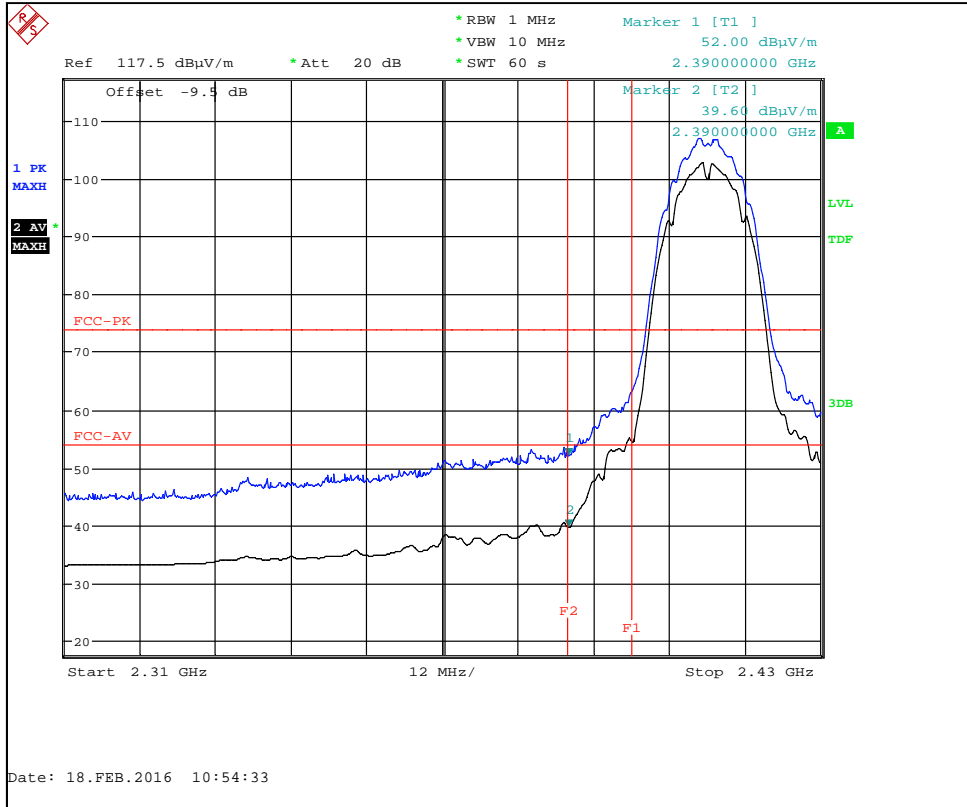

802.11b 1 Mbps Channel 1 : Lower Band Edge

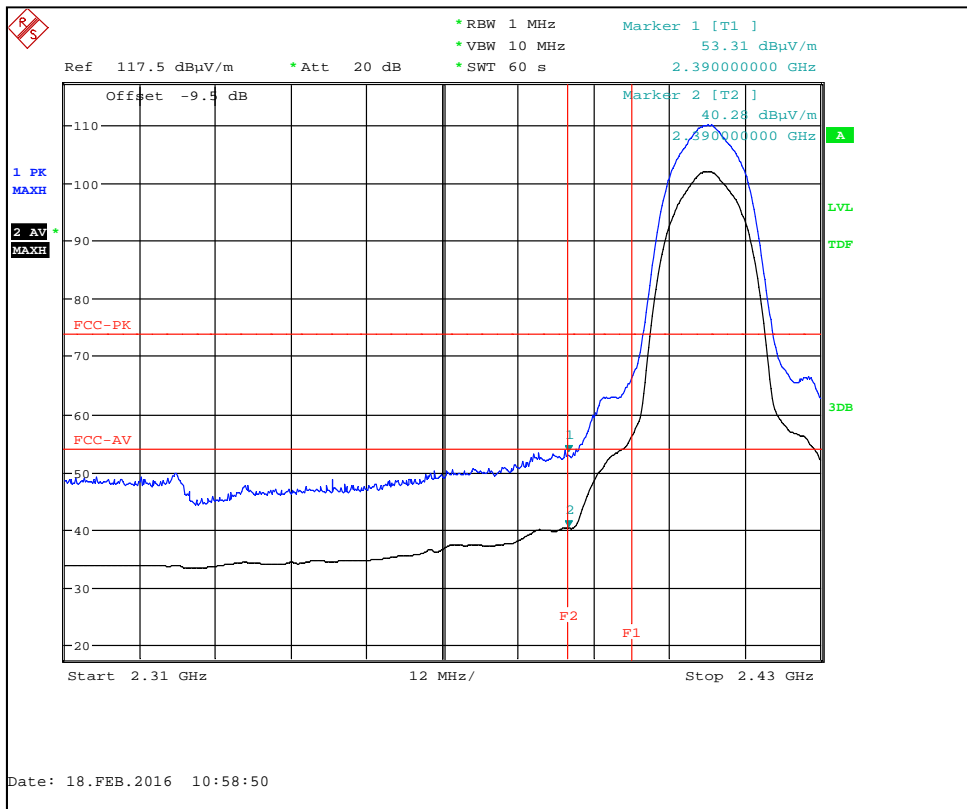

802.11b 11 Mbps Channel 1 : Lower Band Edge

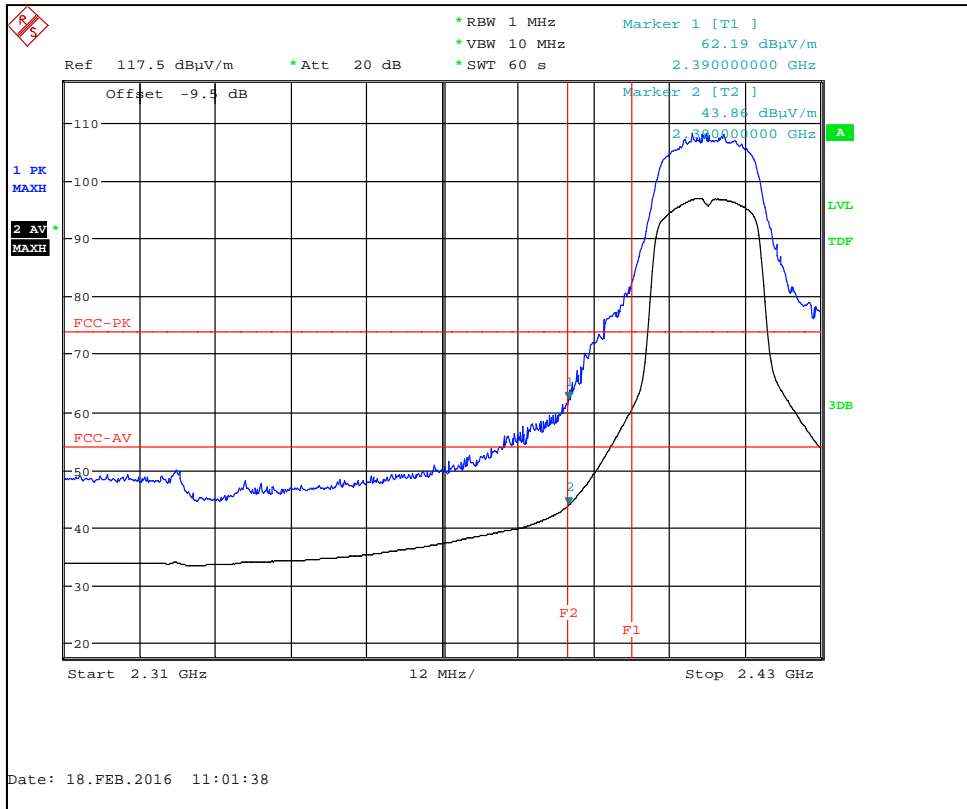

802.11g 6 Mbps Channel 1 : Lower Band Edge

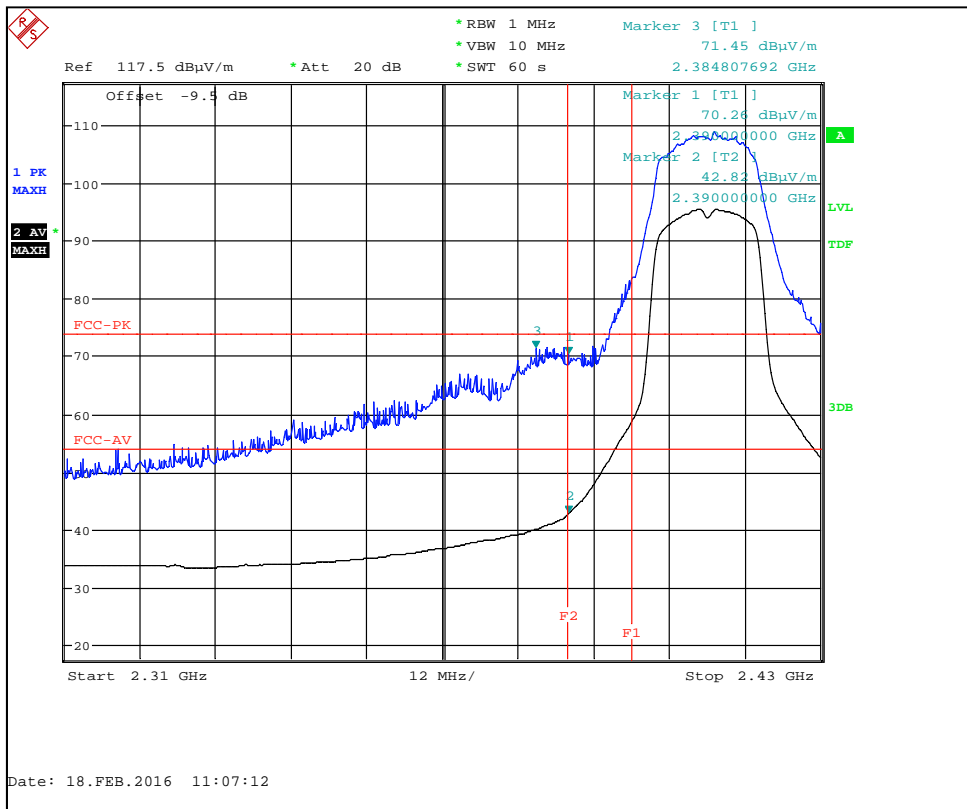

802.11g 54 Mbps Channel 1 : Lower Band Edge

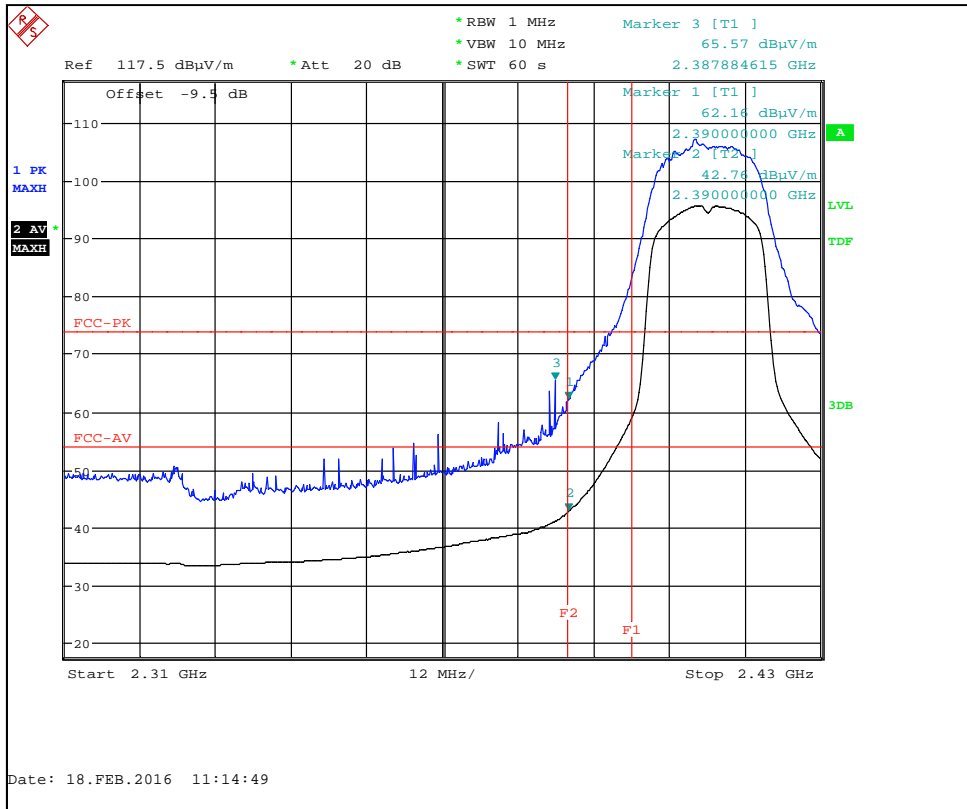

802.11n MCS0 Channel 1 : Lower Band Edge

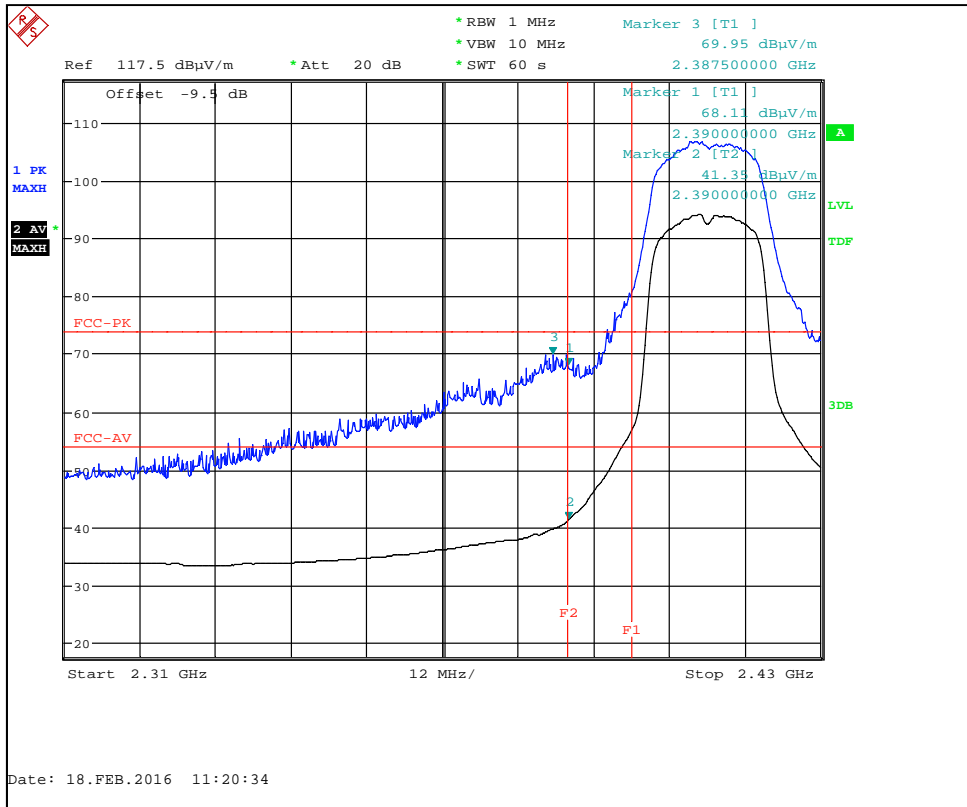

802.11n MCS7 Channel 1 : Lower Band Edge

High Power; Channel: 2437 MHz; 802.11b 11Mbps										
Detector	Freq. (MHz)	Meas'd Emission (dBμV)	Cable Loss (dB)	Antenna Factor (dB/m)	Pre-amp Gain (dB)	Duty Cycle Corr'n (dB)	Distance Extrap'n Factor (dB)	Field Strength (dBμV/m)	Field Strength (μV/m)	Limit (μV/m)
Pk	1000.000	44	3.7	25.3	34.58	0	0	37.4	74.13	5000
Av	1000.000	33.5	3.7	25.3	34.58	0	0	26.9	22.13	500
Pk	1230.882	47.8	3.8	25.5	34.2	0	0	41.9	124.45	5000
Av	1230.882	32.6	3.8	25.5	34.2	0	0	26.7	21.63	500
Pk	2227.601	53.4	6.4	27.9	33.71	0	0	53.1	451.86	5000
Av	2227.601	33.3	6.4	27.9	33.71	0	0	33.0	44.67	500
Pk	4874.038	40.6	8.6	33.2	34.06	0	0	47.7	242.66	5000
Av	4874.038	30.2	8.6	33.2	34.06	0	0	37.3	73.28	500

High Power; Channel: 2462 MHz; 802.11b 1Mbps										
Detector	Freq. (MHz)	Meas'd Emission (dBμV)	Cable Loss (dB)	Antenna Factor (dB/m)	Pre-amp Gain (dB)	Duty Cycle Corr'n (dB)	Distance Extrap'n Factor (dB)	Field Strength (dBμV/m)	Field Strength (μV/m)	Limit (μV/m)
Pk	2483.500	55.93	7.5	28.5	33.78	0	0	57.3	732.82	5000
Av	2483.500	42	7.5	28.5	33.78	0	0	43.4	147.91	500
Pk	2485.016	56.72	7.5	28.5	33.78	0	0	58.1	803.53	5000
Av	2485.016	47.66	7.5	28.5	33.78	0	0	49.0	281.84	500
Pk	2489.262	55.49	7.7	28.5	33.78	0	0	57.1	716.14	5000
Av	2489.262	44.15	7.7	28.5	33.78	0	0	45.7	192.75	500

High Power; Channel: 2462 MHz; 802.11b 11Mbps										
Detector	Freq. (MHz)	Meas'd Emission (dBμV)	Cable Loss (dB)	Antenna Factor (dB/m)	Pre-amp Gain (dB)	Duty Cycle Corr'n (dB)	Distance Extrap'n Factor (dB)	Field Strength (dBμV/m)	Field Strength (μV/m)	Limit (μV/m)
Pk	1000.000	44.7	3.7	25.3	34.58	0	0	38.1	80.35	5000
Av	1000.000	33.2	3.7	25.3	34.58	0	0	26.6	21.38	500
Pk	1230.769	48.2	3.8	25.5	34.2	0	0	42.3	130.32	5000
Av	1230.769	32.3	3.8	25.5	34.2	0	0	26.4	20.89	500
Pk	2227.563	53.8	6.4	27.9	33.71	0	0	53.5	473.15	5000
Av	2227.563	35.7	6.4	27.9	33.71	0	0	35.4	58.88	500
Pk	2483.500	59.06	7.5	28.5	33.78	0	0	60.4	1047.13	5000
Av	2483.500	44.92	7.5	28.5	33.78	0	0	46.3	206.54	500
Pk	2485.496	59.23	7.5	28.5	33.78	0	0	60.6	1071.52	5000
Av	2485.496	45	7.5	28.5	33.78	0	0	46.4	208.93	500
Pk	2489.262	56.1	7.7	28.5	33.78	0	0	57.7	767.36	5000
Av	2489.262	44.8	7.7	28.5	33.78	0	0	46.4	208.93	500
Pk	4923.974	46.9	8.6	33.4	34.08	0	0	54.2	512.86	5000
Av	4923.974	32.3	8.6	33.4	34.08	0	0	39.6	95.50	500

High Power; Channel: 2462 MHz; 802.11g 6Mbps										
Detector	Freq. (MHz)	Meas'd Emission (dBμV)	Cable Loss (dB)	Antenna Factor (dB/m)	Pre-amp Gain (dB)	Duty Cycle Corr'n (dB)	Distance Extrap'n Factor (dB)	Field Strength (dBμV/m)	Field Strength (μV/m)	Limit (μV/m)
Pk	2483.500	64.91	7.5	28.5	33.78	0	0	66.3	2065.38	5000
Av	2483.500	46.1	7.5	28.5	33.78	0	0	47.5	237.14	500
Pk	2484.054	59.28	7.5	28.5	33.78	0	0	60.6	1071.52	5000
Av	2484.054	45.67	7.5	28.5	33.78	0	0	47.0	223.87	500

High Power; Channel: 2462 MHz; 802.11g 54Mbps										
Detector	Freq. (MHz)	Meas'd Emission (dBμV)	Cable Loss (dB)	Antenna Factor (dB/m)	Pre-amp Gain (dB)	Duty Cycle Corr'n (dB)	Distance Extrap'n Factor (dB)	Field Strength (dBμV/m)	Field Strength (μV/m)	Limit (μV/m)
Pk	2483.500	67.8	7.5	28.5	33.78	0	0	69.2	2884.03	5000
Av	2483.500	44.98	7.5	28.5	33.78	0	0	46.3	206.54	500
Pk	2484.855	68.3	7.5	28.5	33.78	0	0	69.7	3054.92	5000
Av	2484.855	44.1	7.5	28.5	33.78	0	0	45.5	188.36	500
Pk	2487.339	65.8	7.6	28.5	33.78	0	0	67.3	2317.39	5000
Av	2487.339	43.2	7.6	28.5	33.78	0	0	44.7	171.79	500

High Power; Channel: 2462 MHz; 802.11n MCS0										
Detector	Freq. (MHz)	Meas'd Emission (dBμV)	Cable Loss (dB)	Antenna Factor (dB/m)	Pre-amp Gain (dB)	Duty Cycle Corr'n (dB)	Distance Extrap'n Factor (dB)	Field Strength (dBμV/m)	Field Strength (μV/m)	Limit (μV/m)
Pk	2483.500	61.2	7.5	28.5	33.78	0	0	62.6	1348.96	5000
Av	2483.500	47	7.5	28.5	33.78	0	0	48.4	263.03	500
Pk	2485.496	63.5	7.5	28.5	33.78	0	0	64.9	1757.92	5000
Av	2485.496	44.5	7.5	28.5	33.78	0	0	45.9	197.24	500

High Power; Channel: 2462 MHz; 802.11n MCS7										
Detector	Freq. (MHz)	Meas'd Emission (dBμV)	Cable Loss (dB)	Antenna Factor (dB/m)	Pre-amp Gain (dB)	Duty Cycle Corr'n (dB)	Distance Extrap'n Factor (dB)	Field Strength (dBμV/m)	Field Strength (μV/m)	Limit (μV/m)
Pk	2483.500	61.52	7.5	28.5	33.78	0	0	62.9	1396.37	5000
Av	2483.500	45.1	7.5	28.5	33.78	0	0	46.5	211.35	500
Pk	2485.096	60.47	7.5	28.5	33.78	0	0	61.8	1230.27	5000
Av	2485.096	45.8	7.5	28.5	33.78	0	0	47.2	229.09	500
Pk	2487.820	65.8	7.6	28.5	33.78	0	0	67.3	2317.39	5000
Av	2487.820	47	7.6	28.5	33.78	0	0	48.5	266.07	500

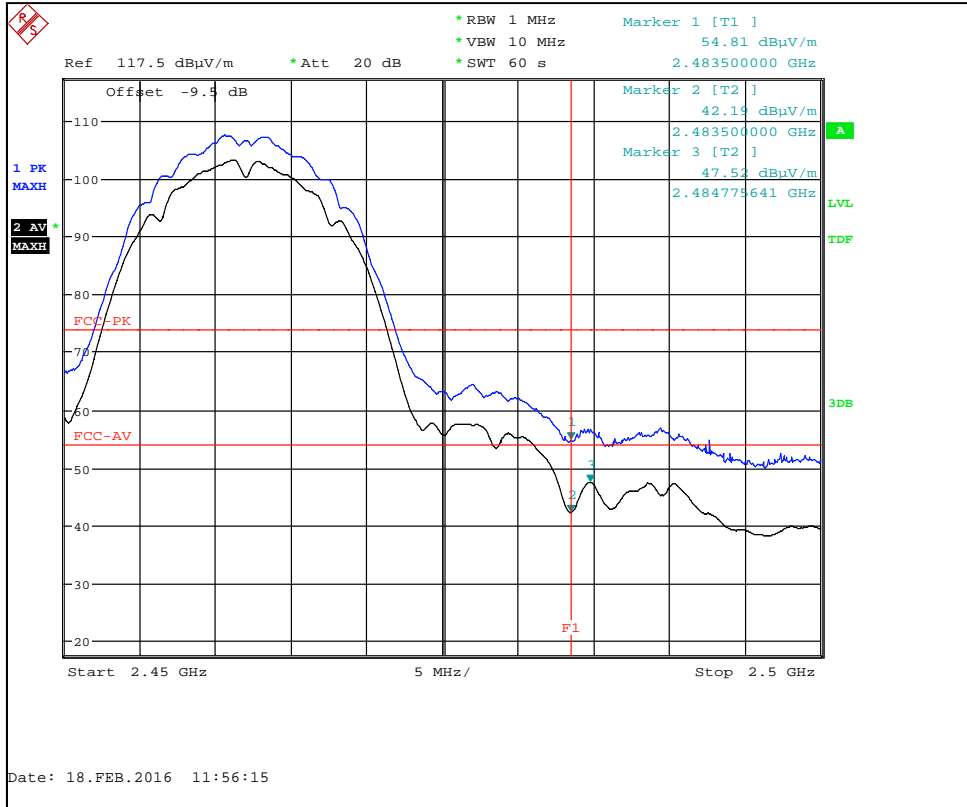

802.11b 1 Mbps Channel 11 : Upper Band Edge

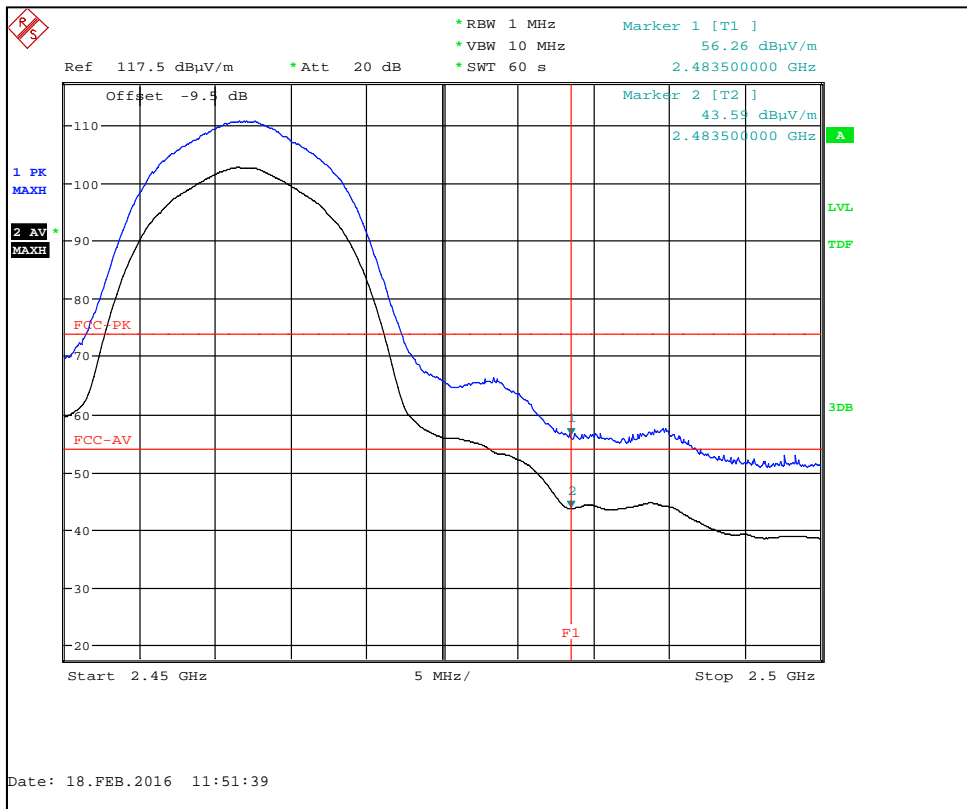

802.11b 11 Mbps Channel 11 : Upper Band Edge

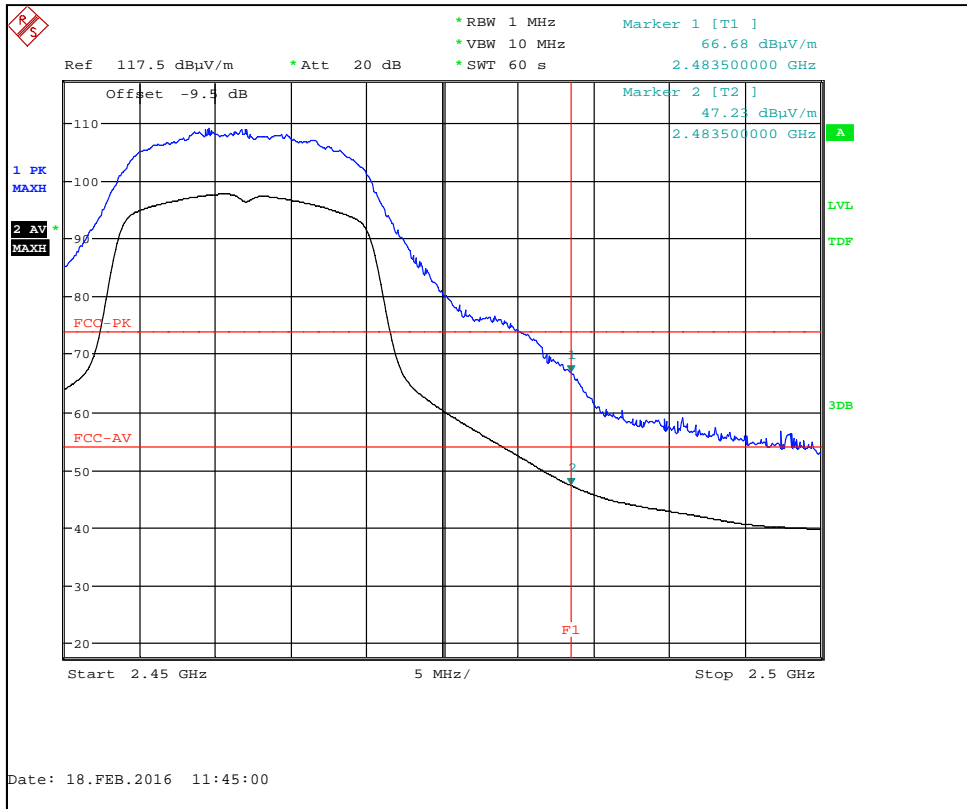

802.11g 6 Mbps Channel 11 : Upper Band Edge

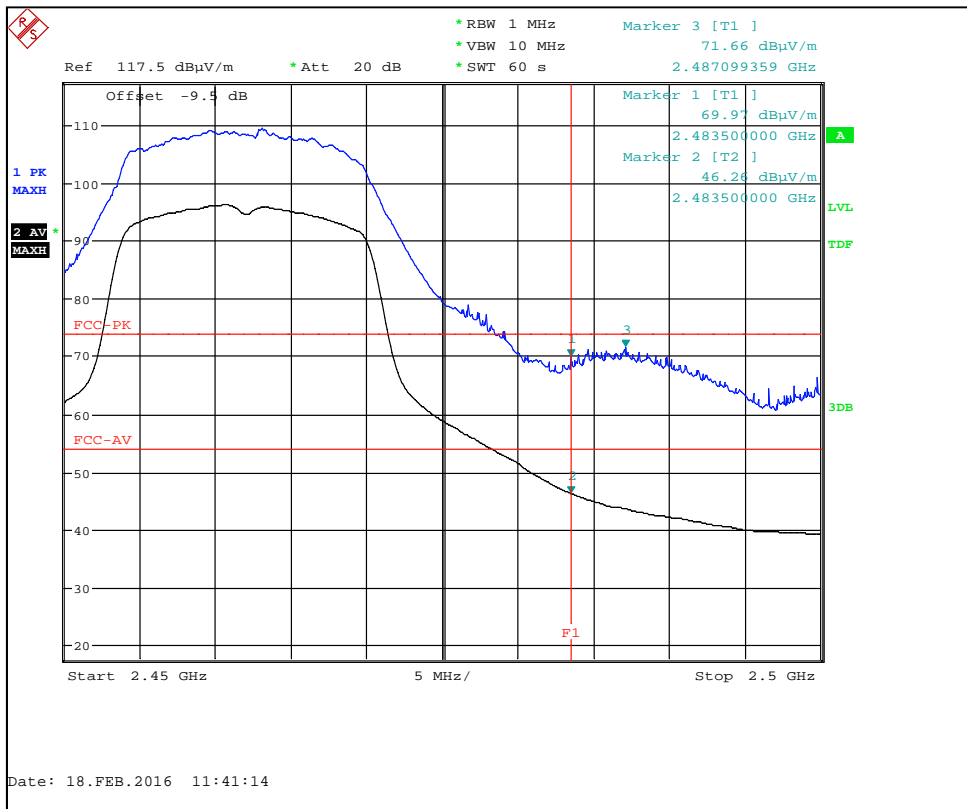

802.11g 54 Mbps Channel 11 : Upper Band Edge

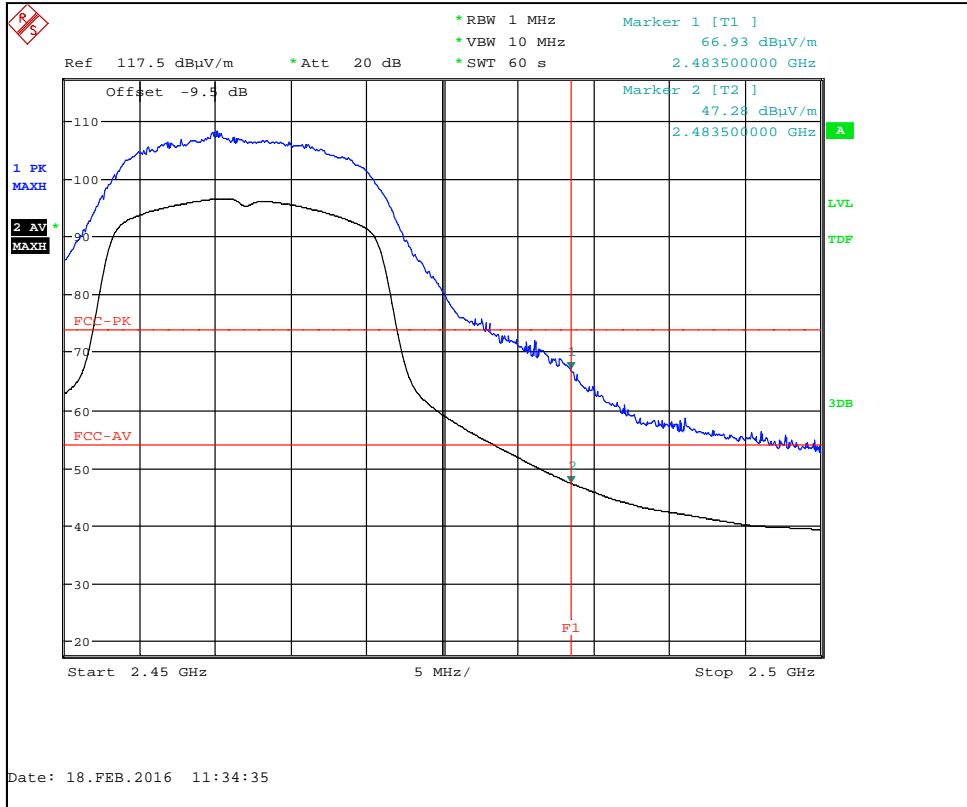

802.11n MCS0 Channel 11 : Upper Band Edge

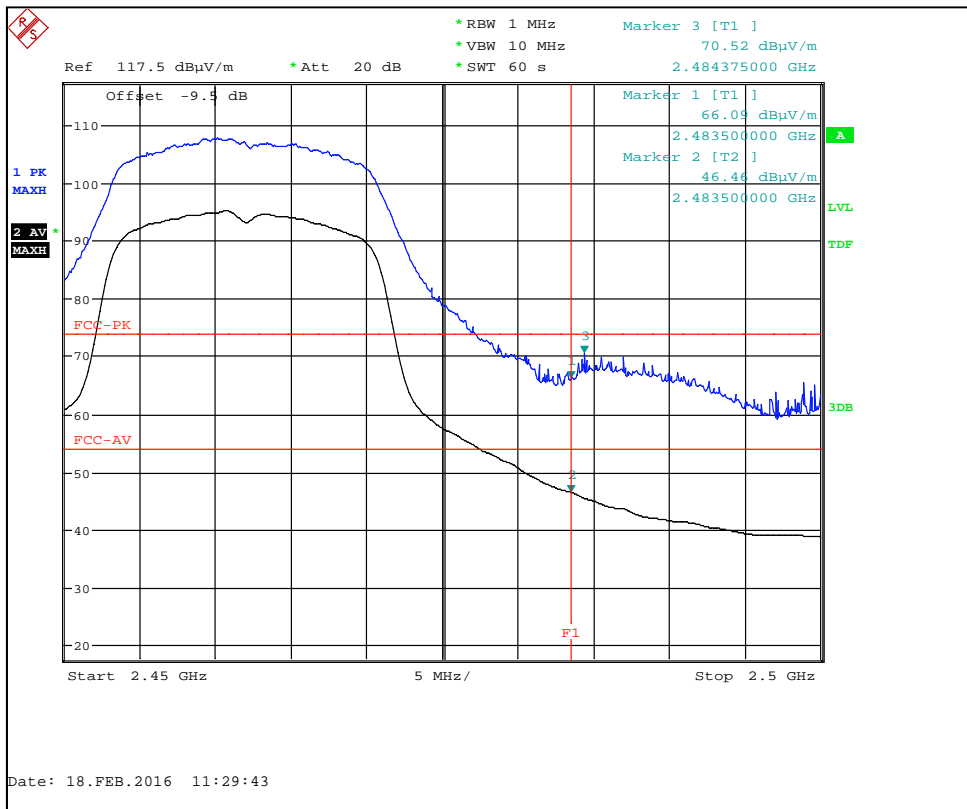

802.11n MCS7 Channel 11 : Upper Band Edge

12 AC power-line conducted emissions

12.1 Definition

Line-to-ground radio-noise voltage that is conducted from all of the EUT current-carrying power input terminals that are directly (or indirectly via separate transformers or power supplies) connected to a public power network.

12.2 Test Parameters

Test Location:	Element Hull
Test Chamber:	Lab 7
Test Standard and Clause:	ANSI C63.10-2013, Clause 6.2
EUT Channels / Frequencies Measured:	Mid
EUT Channel Bandwidths:	20 MHz
EUT Modulation:	802.11b/g/n
Deviations From Standard:	None
Measurement BW:	9 kHz
Measurement Detectors:	Quasi-Peak and Average, RMS

Environmental Conditions (Normal Environment)

Temperature: 22 °C	+15 °C to +35 °C (as declared)
Humidity: 32 % RH	20 % RH to 75 % RH (as declared)
Supply: 110 V ac	110 V ac ±10 % (as declared)

12.3 Test Limit

A radio apparatus that is designed to be connected to the public utility (AC) power line shall ensure that the radio frequency voltage, which is conducted back onto the AC power line on any frequency or frequencies within the band 150 kHz to 30 MHz, shall not exceed the limits in Table 3.

Table 3 – AC Power Line Conducted Emission Limits

Frequency (MHz)	Conducted limit (dB μ V)	
	Quasi-Peak	Average**
0.15 to 0.5	66 to 56	56 to 46
0.5 to 5	56	46
5 to 30	60	50

*The level decreases linearly with the logarithm of the frequency.

**A linear average detector is required.

12.4 Test Method

With the EUT setup in a screened room, as per section 9 of this report and connected as per Figure ii, the power line emissions were measured on a spectrum analyzer / EMI receiver.

AC power line conducted emissions from the EUT are checked first by preview scans with peak and average detectors covering both live and neutral lines. A spectrum analyzer is used to determine if any periodic emissions are present.

Formal measurements using the correct detector(s) and bandwidth are made on frequencies identified from the preview scans. Final measurements were performed with EUT set at its maximum duty in transmit and receive modes.

Figure ii Test Setup

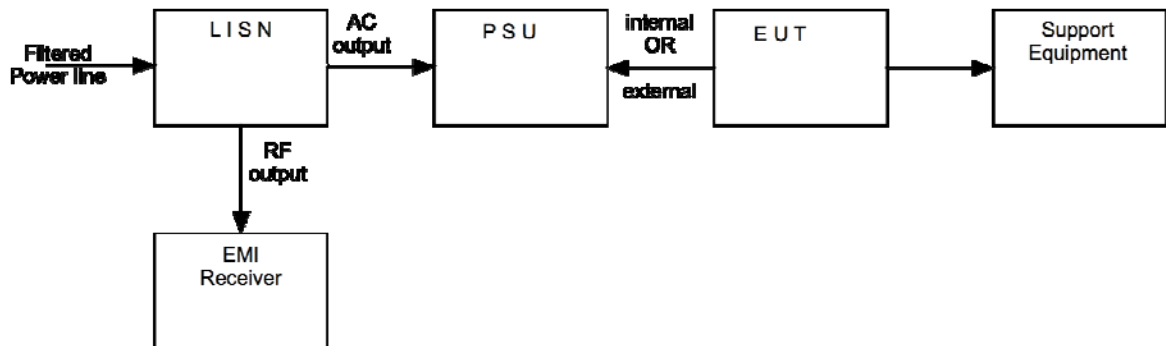

12.5 Test Set-up Photograph

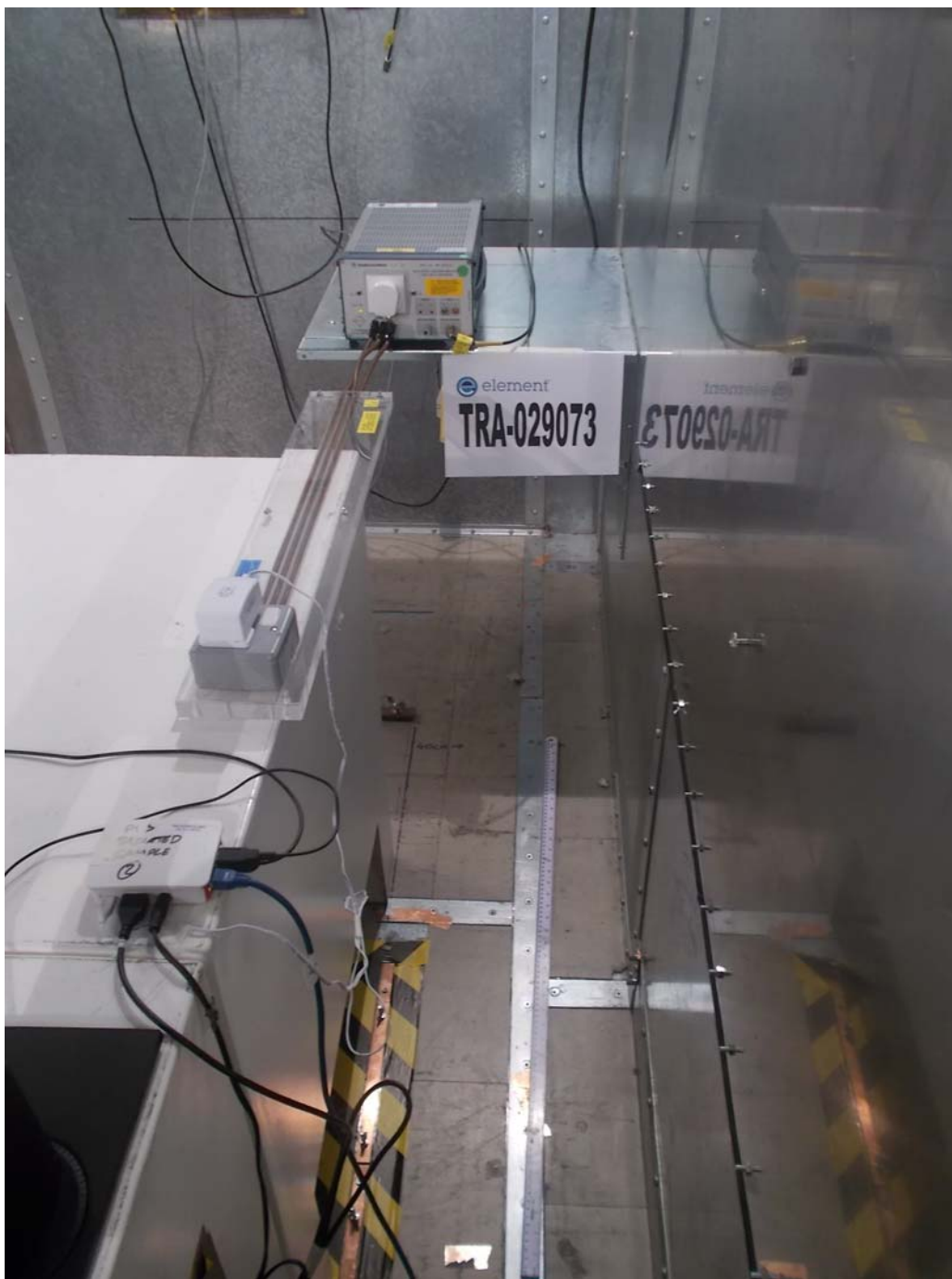

12.6 Test Equipment

Equipment Type	Manufacturer	Equipment Description	Element No	Due For Calibration	Calibration Interval (m)
ESH3-Z5	R & S	LISN	RFG189	08/09/2016	12
ESH3-Z2	R & S	Pulse Limiter	RFG674	02/04/2016	12
ESC17	R & S	Test Receiver	RFG715	06/10/2016	12

12.7 Test Results

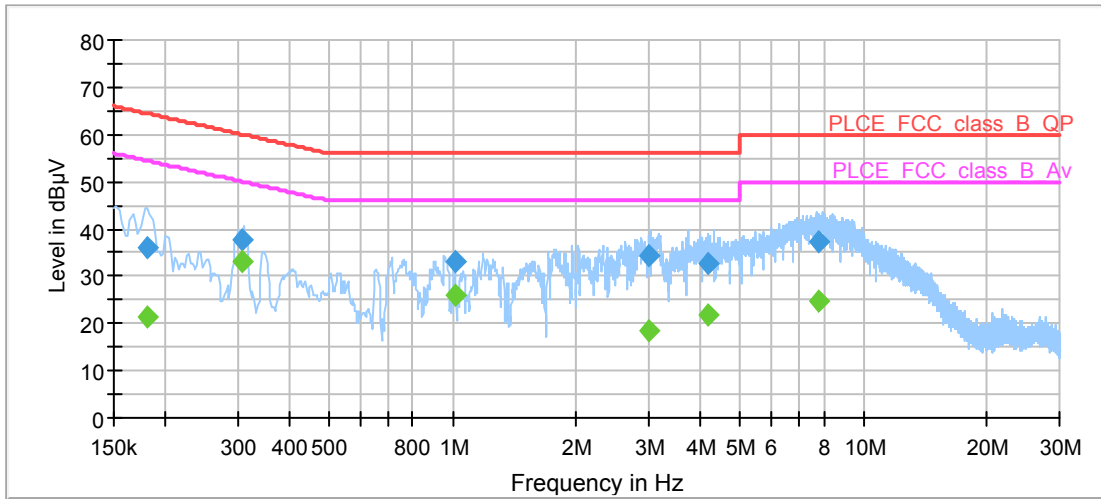

Frequency (MHz)	QuasiPeak (dBµV)	Meas. Time (ms)	Bandwidth (kHz)	PE	Line	Corr. (dB)	Margin (dB)	Limit (dBµV)
0.180600	36.1	15000.0	9.000	GND	L1	10.2	28.3	64.5
0.307550	37.7	15000.0	9.000	GND	L1	10.2	22.4	60.0
1.014800	33.2	15000.0	9.000	GND	N	10.1	22.8	56.0
3.021125	34.5	15000.0	9.000	GND	L1	10.1	21.5	56.0
4.194825	32.7	15000.0	9.000	GND	L1	10.2	23.3	56.0
7.788000	37.4	15000.0	9.000	GND	L1	10.5	22.6	60.0

Frequency (MHz)	Average (dBµV)	Meas. Time (ms)	Bandwidth (kHz)	PE	Line	Corr. (dB)	Margin (dB)	Limit (dBµV)
0.180600	21.4	15000.0	9.000	GND	L1	10.2	33.0	54.5
0.307550	33.1	15000.0	9.000	GND	L1	10.2	16.9	50.0
1.014800	25.9	15000.0	9.000	GND	N	10.1	20.1	46.0
3.021125	18.5	15000.0	9.000	GND	L1	10.1	27.5	46.0
4.194825	21.9	15000.0	9.000	GND	L1	10.2	24.1	46.0
7.788000	24.9	15000.0	9.000	GND	L1	10.5	25.1	50.0

13 Occupied Bandwidth

13.1 Definition

The emission bandwidth (-6 dB) is defined as the frequency range between two points, one above and one below the carrier frequency, at which the spectral density of the emission is attenuated 6 dB below the maximum in-band spectral density of the modulated signal.

13.2 Test Parameters

Test Location:	Element Hull
Test Chamber:	Lab 4
Test Standard and Clause:	IC: ANSI C63.10-2013, Clause 6.9 FCC: ANSI C63.10-2013, Clause 11.8
EUT Channels / Frequencies Measured:	Low / Mid / High
EUT Channel Bandwidths:	20 MHz
EUT Test Modulations:	802.11b/g/n
Deviations From Standard:	None
Measurement BW: (IC requirement: 1% to 5% OBW; FCC requirement: 100 kHz)	100 kHz (and 20 kHz / 500 kHz for RSS, see plots)
Spectrum Analyzer Video BW: (requirement at least 3x RBW)	300 kHz (or >3xRBW, see plots)
Measurement Span: (requirement 2 to 5 times OBW)	3, 20 or 30 MHz (see plots)
Measurement Detector:	Peak

Environmental Conditions (Normal Environment)

Temperature: 22 °C	+15 °C to +35 °C (as declared)
Humidity: 32 % RH	20 % RH to 75 % RH (as declared)
Supply: 110 V ac/dc	110 V ac ±10 % (as declared)

13.3 Test Limit

The minimum -6 dB bandwidth shall be at least 500 kHz.

13.4 Test Method

With the EUT setup as per section 9 of this report and connected as per Figure iii, the bandwidth of the EUT was measured on a spectrum analyser.

The measurements were performed with EUT set at its maximum duty. All modulation schemes, data rates and power settings were used to observe the worst-case configuration in each bandwidth.

Figure iii Test Setup

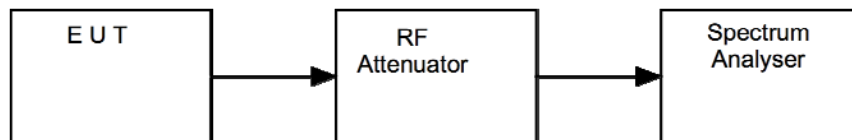

13.5 Test Equipment

<i>Type of Equipment</i>	<i>Maker/Supplier</i>	<i>Model Number</i>	<i>Element Number</i>	<i>Calibration Due Date</i>	<i>Calibration Interval (m)</i>
Spectrum Analyser	Agilent	N9030A	REF2167	13/10/2016	12

13.6 Test Results

RSS-247. Modulation: 802.11b; Data rate: 1 Mbps; Power setting: Full			
Channel Frequency (MHz)	99% Bandwidth (kHz)	6dB Bandwidth (kHz)	Result
2412	14174	9388	PASS
2437	14177	9397	PASS
2462	14183	9405	PASS

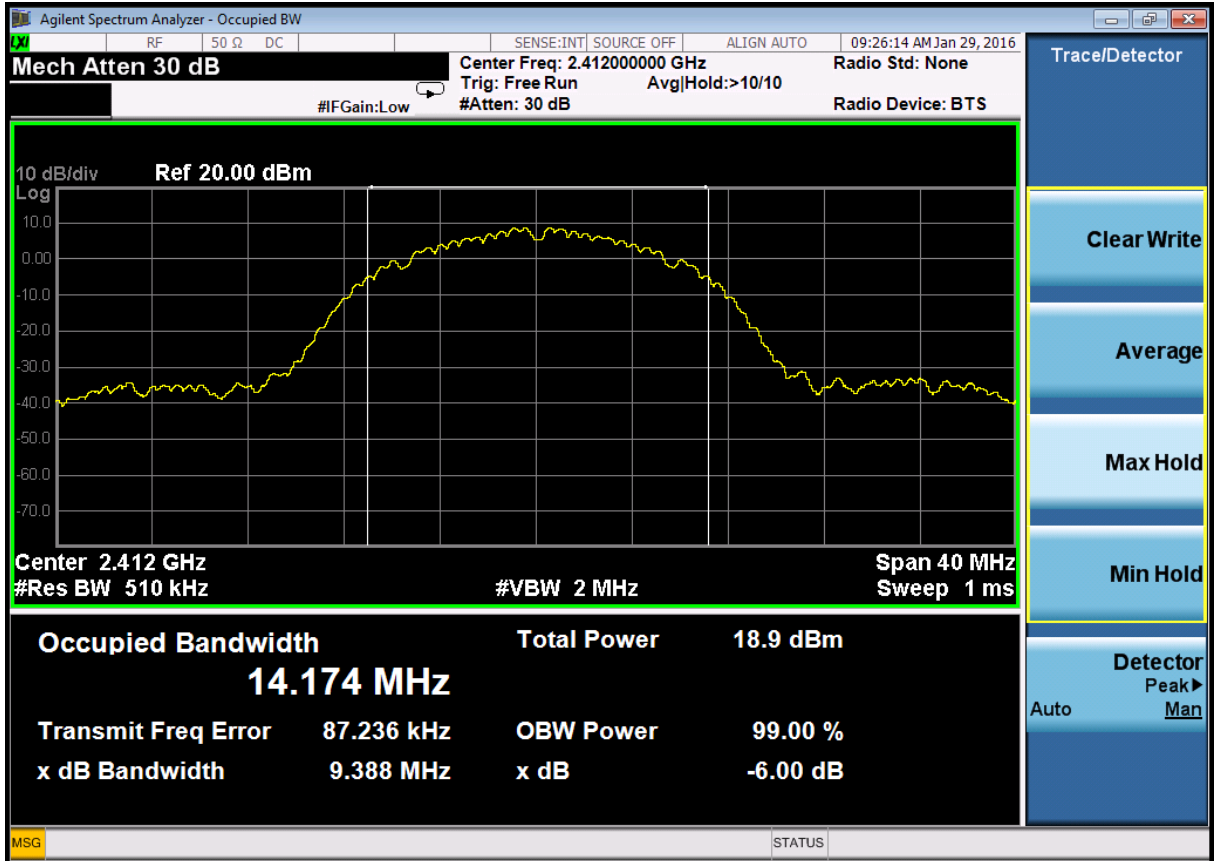

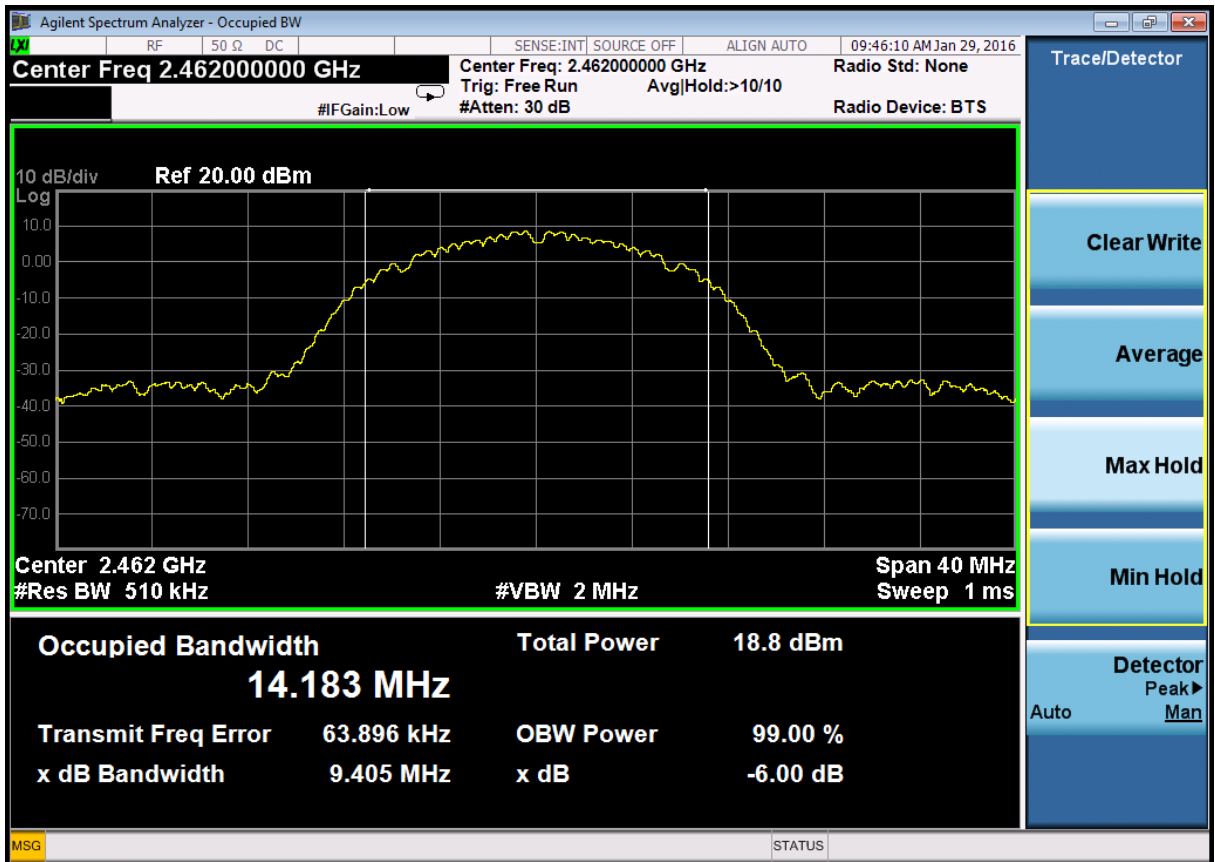
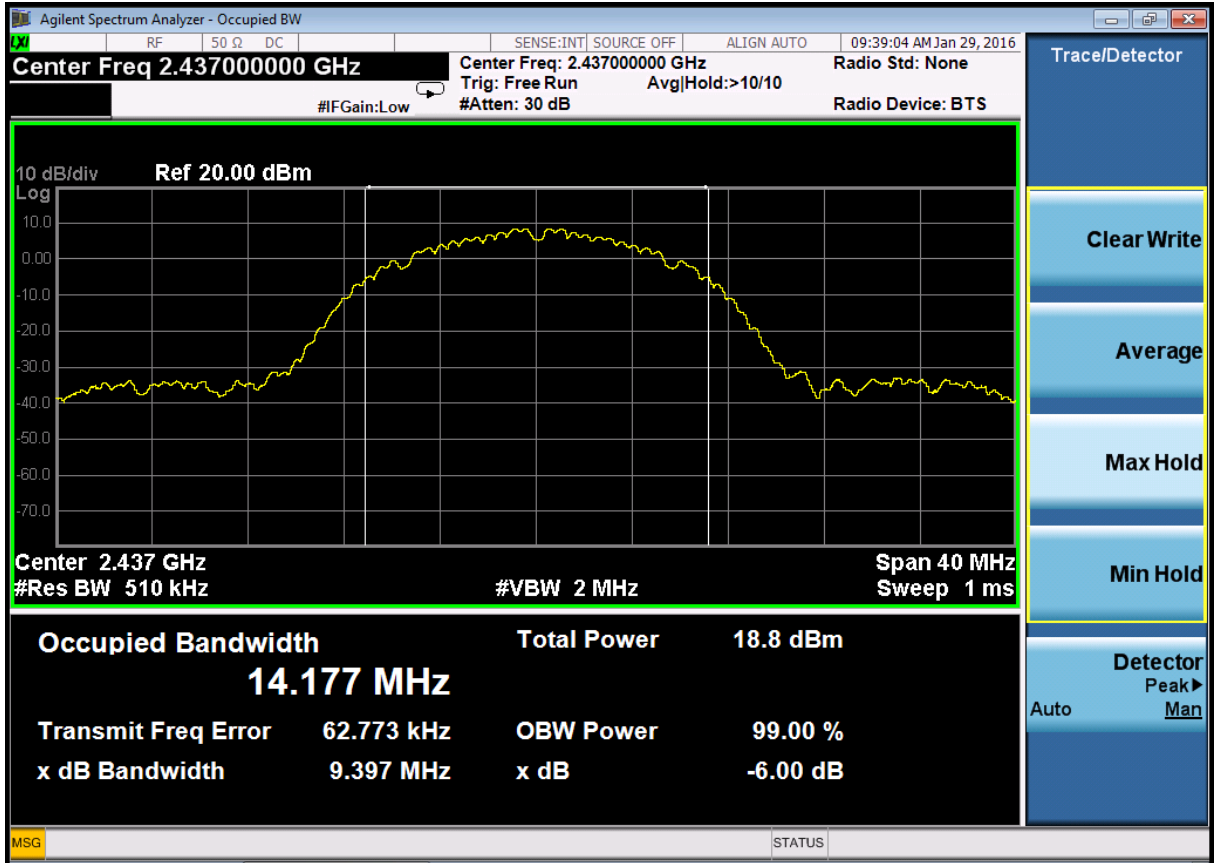

RSS-247. Modulation: 802.11b; Data rate: 11 Mbps; Power setting: Full

Channel Frequency (MHz)	99% Bandwidth (kHz)	6dB Bandwidth (kHz)	Result
2412	13951	8756	PASS
2437	13938	9097	PASS
2462	13939	9056	PASS

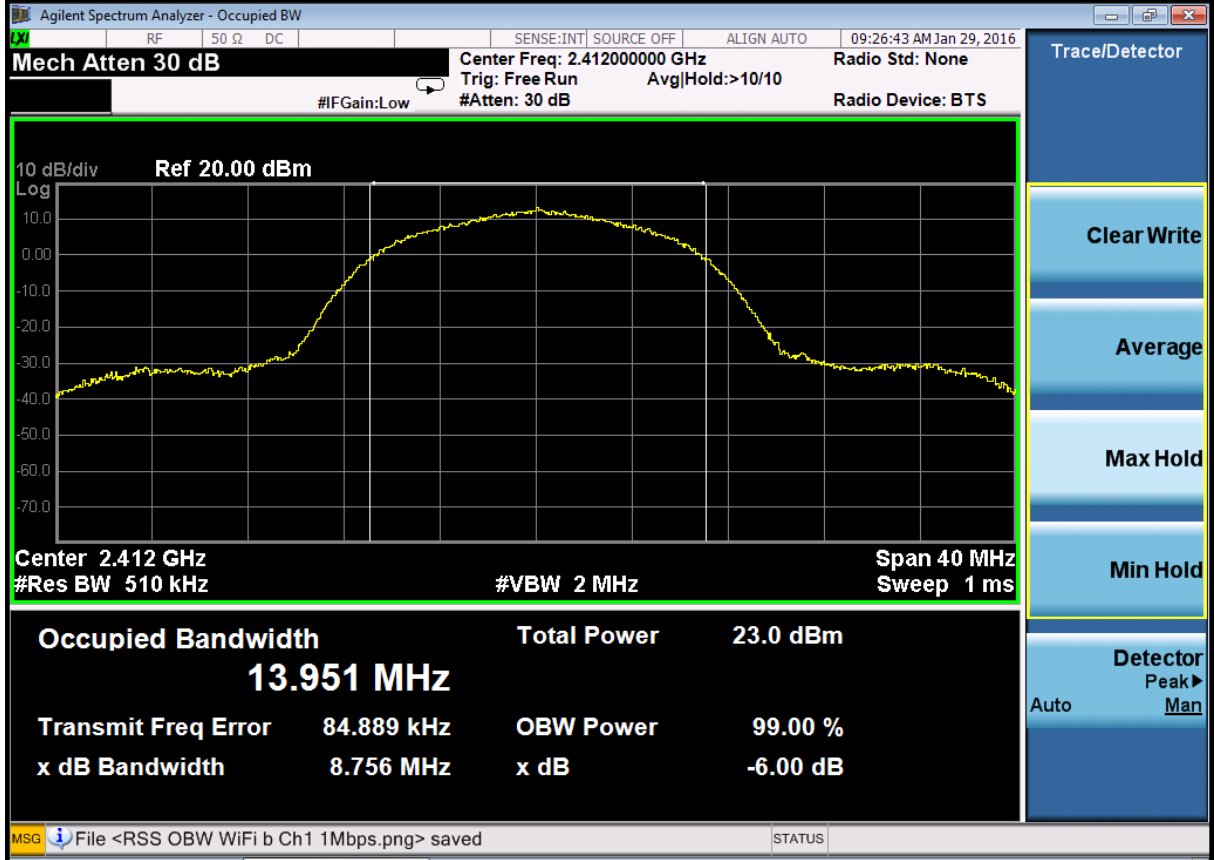

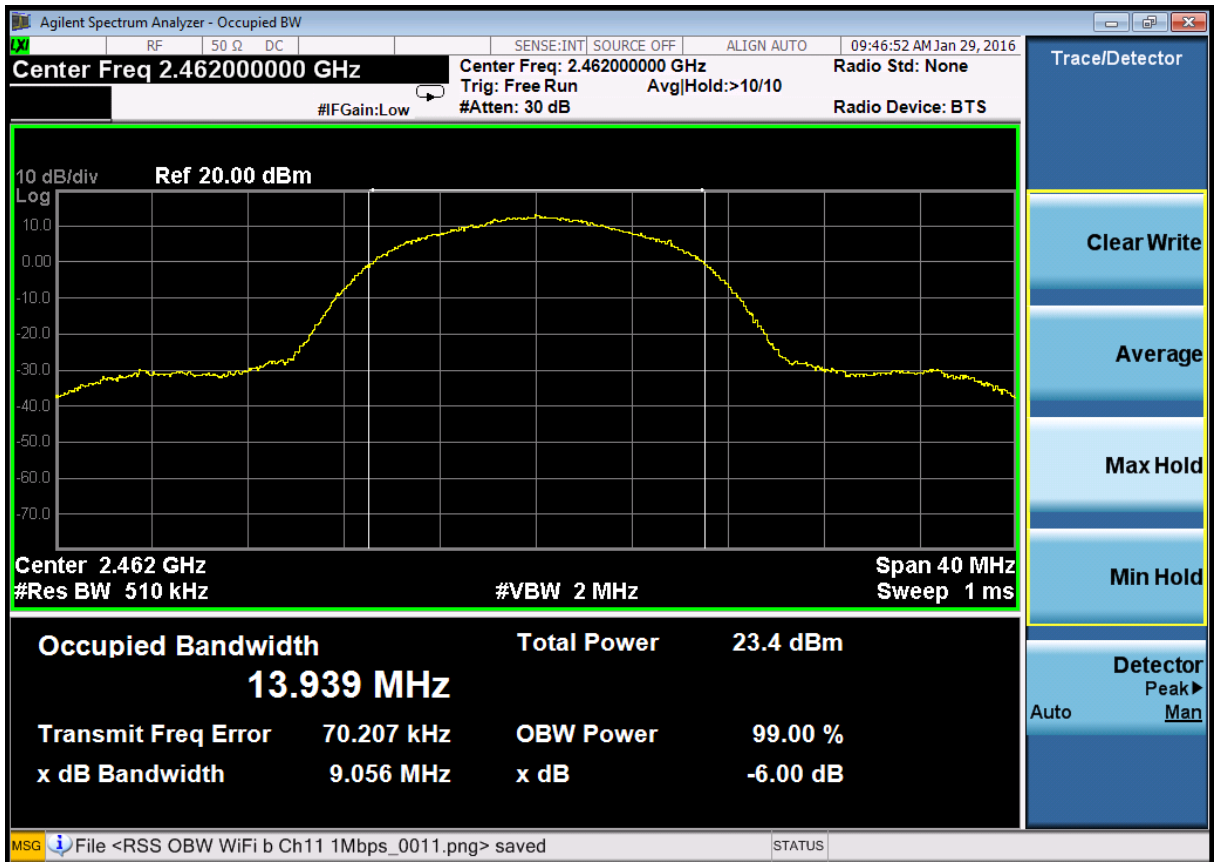
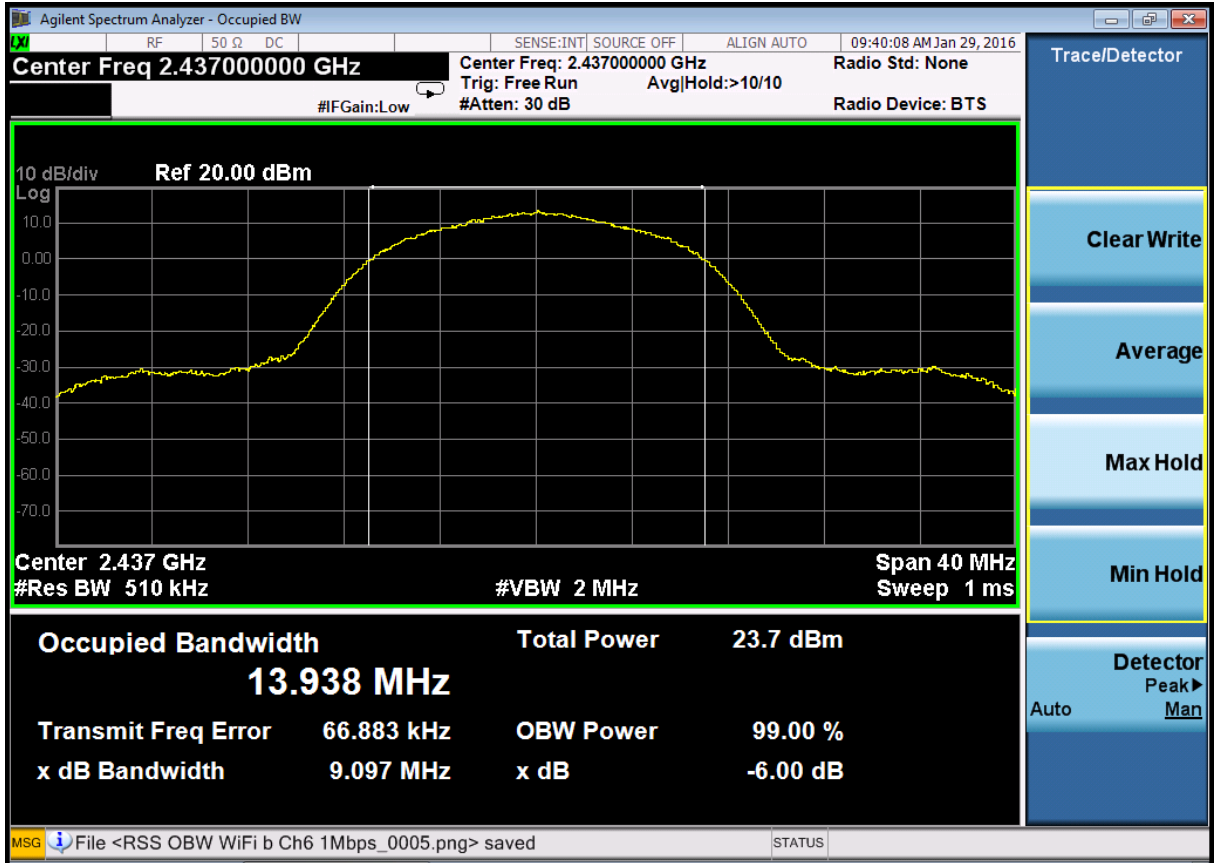

RSS-247. Modulation: 802.11g; Data rate: 6 Mbps; Power setting: Full			
Channel Frequency (MHz)	99% Bandwidth (kHz)	6dB Bandwidth (kHz)	Result
2412	16974	15680	PASS
2437	16913	15650	PASS
2462	17043	15670	PASS

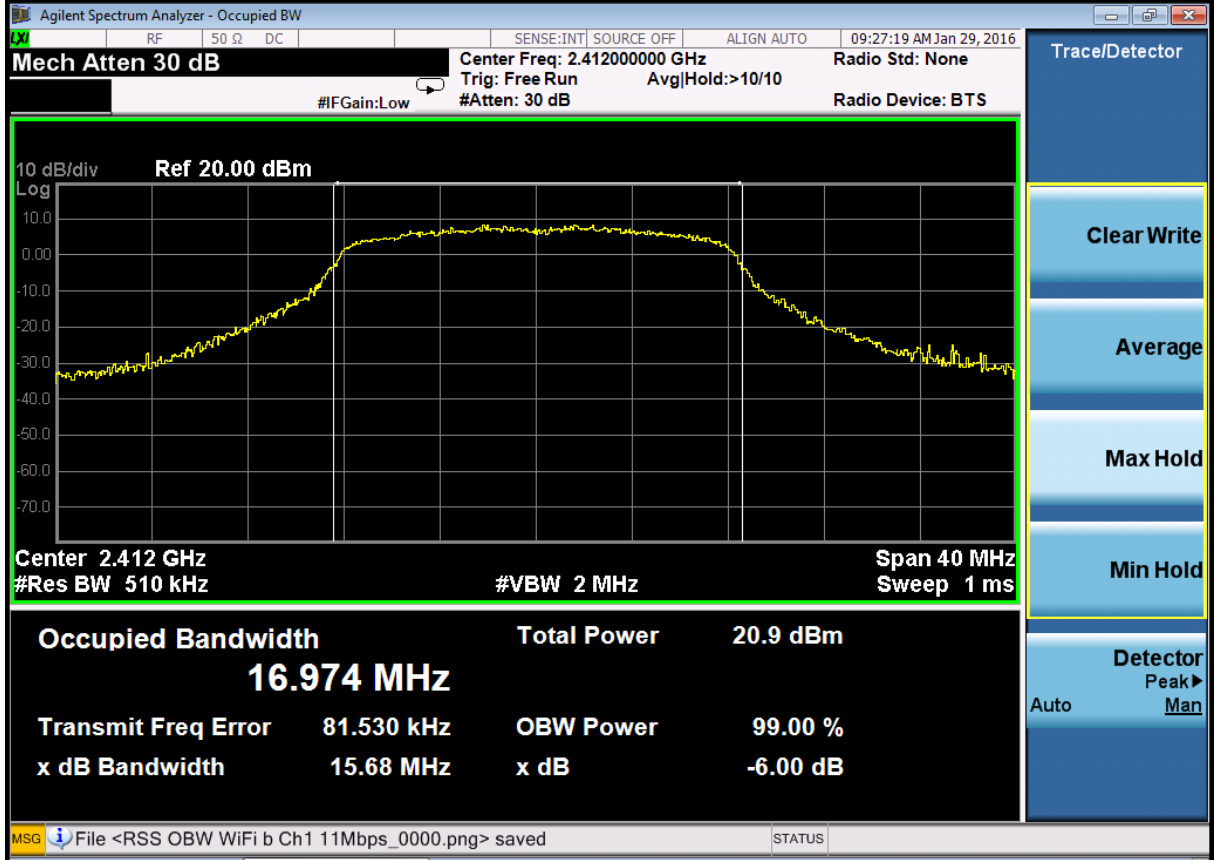

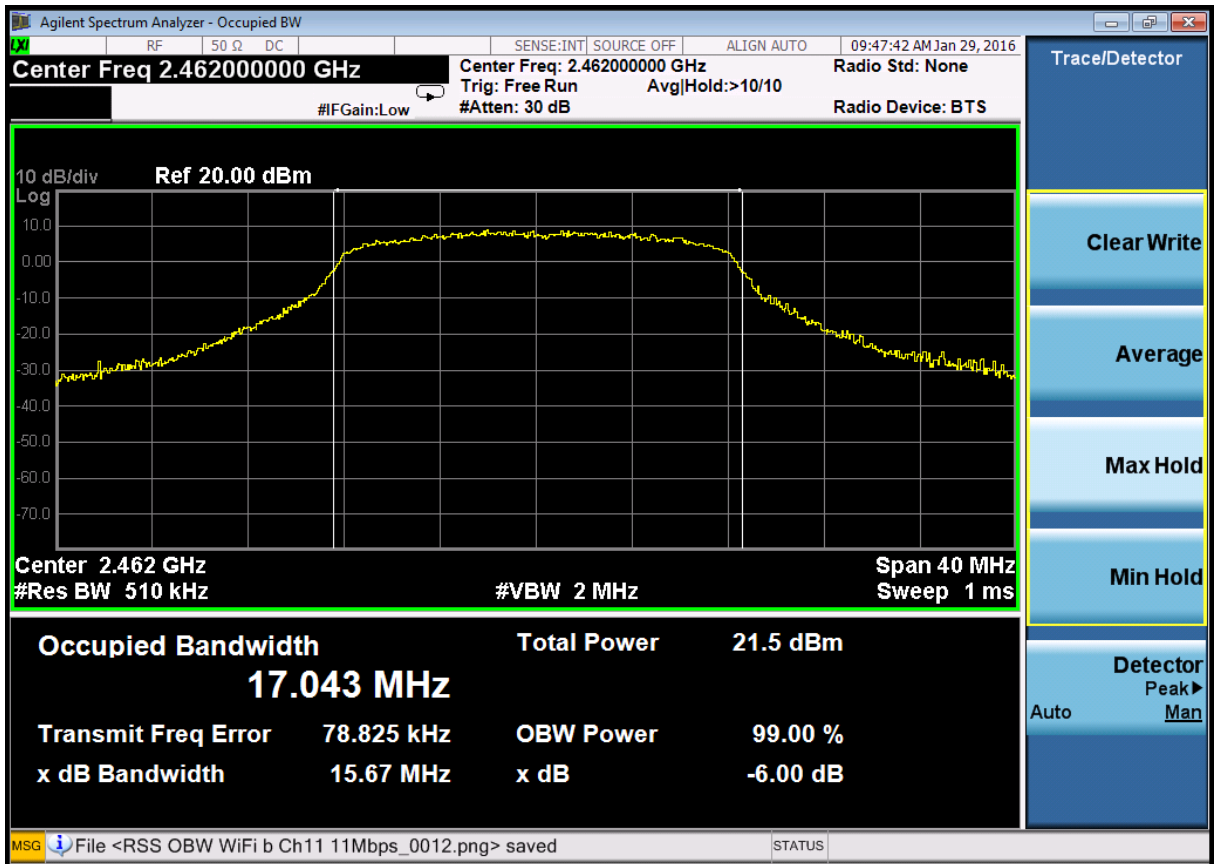
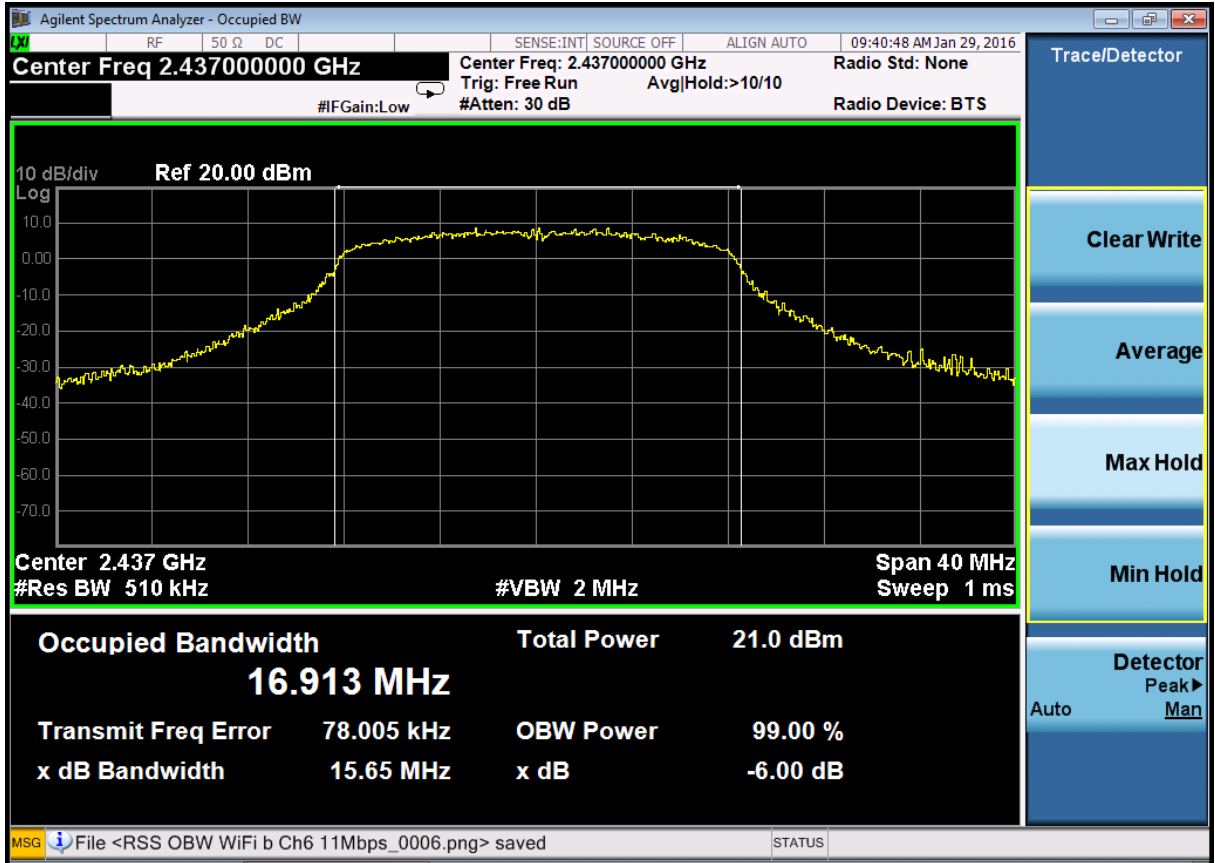

RSS-247. Modulation: 802.11g; Data rate: 54 Mbps; Power setting: Full			
Channel Frequency (MHz)	99% Bandwidth (kHz)	6dB Bandwidth (kHz)	Result
2412	16805	15950	PASS
2437	16851	15590	PASS
2462	16867	15890	PASS

